

RADIO'S GREATEST MAGAZINE

# RADIO-CRAFT

Incorporating

**RADIO &  
TELEVISION**

HUGO GERNSBACK, Editor



See Page 142



MANY ARTICLES  
FOR THE

**RADIO  
BEGINNER**

DECEMBER

25¢

CANADA 30¢

1942

OVER 100 ILLUSTRATIONS



# FREE Lesson in Radio

## Here is a Partial List of Subjects This Lesson Teaches

With 31 Photos, Sketches, Radio Drawings

- How superheterodyne receivers work
- How to remove tubes, tube shields
- Three reasons why radio tubes fail
- Electrodynamic loudspeaker:
  - How it works
  - Replacing damaged cone
  - Recentering voice coil
  - Remedies for open field coil
- Output transformer construction, repair
- Gang tuning condenser:
  - Construction of rotor, stator
  - How capacity varies
  - Restraining dial cord
  - Straightening bent rotor plates

- I. F. transformers—
  - What they do, repair hints
- How to locate defective soldered joints

## GETTING ACQUAINTED WITH RECEIVER SERVICING

- Inside story of carbon resistors
- Paper, electrolytic, mica, trimmer condensers
- How condensers become shorted, leaky
- Antenna, oscillator coil facts
- Power transformer: construction, possible troubles
- Installing power cord
- Troubles of combination volume control, on-off switch
- Tone controls
- Dial lamp connections
- Receiver servicing technique:
  - Checking performance
  - Testing tubes
  - Circuit disturbance test
  - Isolating defective stage
  - Locating defective part



J. E. SMITH, President  
NATIONAL RADIO INSTITUTE  
Established 28 Years

## See For Yourself How I Train You at Home to BE A RADIO TECHNICIAN

Mail the Coupon for a FREE lesson from my Radio Course. It shows how N.R.I. trains you for Radio at home in spare time. And with this sample lesson I'll send my 64-page illustrated book, **RICH REWARDS IN RADIO**. It describes the many fascinating jobs Radio offers, explains how N.R.I. teaches you with interesting, illustrated lessons and **SIX BIG KITS OF RADIO PARTS!**

### Build These and Other Radio Circuits with Kits I Send

By the time you've conducted 60 sets of Experiments with Radio Parts I supply—have made hundreds of measurements and adjustments—you'll have valuable, **PRACTICAL** experience for a good full time or part time job in Radio!

You build this **SUPER-HETERODYNE CIRCUIT** containing a preselector, oscillator-mixer-first detector, I. F. stage, diode-detector-a.v.c. stage and audio stage. It will bring in local and distant stations. You get the thrill of learning at home evenings in spare time while you put the set through fascinating tests!



You make this **MEASURING INSTRUMENT** yourself early in the Course, useful for practical Radio work on neighborhood Radios to pick up **EXTRA** spare time money. It is a vacuum tube voltmeter and millimeter, measures A. C., D. C. and R. F. volts, D. C. currents, Resistance, Receiver Output.



**\$10 a Week in Spare Time**  
"I repaired some Radio sets when I was on my tenth lesson. I really don't see how you can give so much for such a small amount of money. I made \$600 in a year and a half, and I have made an average of \$10 a week—just spare time." **JOHN JERRY**, 1337 Kalamath St., Denver, Colorado.

**\$200 a Month in Own Business**  
"For several years I have been in business for myself making around \$200 a month. Business has steadily increased. I have N.R.I. to thank for my start in this field." **ARLIE J. FROEHRER**, 300 W. Texas Ave., Goose Creek, Texas.



### Act Now! Many Radio Technicians Make \$30, \$40, \$50, a Week

Right now, in nearly every neighborhood, there's room for more spare and full time Radio Technicians. Many Radio Technicians are stepping into **FULL** time Radio jobs, or are starting their own shops, and making \$30, \$40, \$50 a week!

Others take good-pay jobs with Broadcasting Stations. Hundreds more are needed for Government jobs as Civilian Radio Operators, Technicians, Radio Manufacturers, rushing to fill Government orders, need trained men. Aviation, Police, Commercial Radio and Loud-speaker Systems are live, growing fields. And think of the **NEW** jobs Television and other Radio developments will open after the war! I give you the Radio knowledge required for these fields.

### My "50-50 Method" Helps Many Make \$5, \$10 a Week EXTRA While Learning

Many N.R.I. students make \$5, \$10 a week extra money fixing Radios in spare time while learning. I send **EXTRA MONEY JOB SHEETS** that tell how to do it!

My "50-50 Method"—half building and testing Radio Circuits with the six kits of Radio parts I send, half learning from illustrated lessons—makes you "old friends" with Radio before you know it. You run your own spare time shop, get practice fixing friends' Radios, get paid while training!

### Find Out What N.R.I. Can Do for You

MAIL COUPON NOW for FREE sample Lesson and 64-page illustrated book. You'll see the many fascinating jobs Radio offers and how you can train at home. If you want to jump your pay—Mail Coupon AT ONCE! **J. E. SMITH**, President, Dept. 2NX, National Radio Institute, Washington, D. C.

**\* TRAINING MEN FOR VITAL RADIO JOBS**



### Extra Pay in Army, Navy too



Men likely to go into military service, soldiers, sailors, marines, should mail the Coupon Now! Learning Radio helps men get extra rank, extra prestige, more interesting duties, **MUCH HIGHER PAY**. Also prepares for good Radio jobs after service ends. Hundreds of service men now enrolled.

## GOOD FOR BOTH 64 PAGE BOOK SAMPLE LESSON FREE

MR. J. E. SMITH, President, Dept. 2NX  
NATIONAL RADIO INSTITUTE, Washington, D. C.  
Mail me FREE, without obligation, Sample Lesson and 64-page book, "Rich Rewards in Radio." (No Salesman will call. Write plainly.)

Age .....

Name .....

Address .....

City ..... State ..... AFR-2



# RADIO-CRAFT

Incorporating

**RADIO & TELEVISION**

**HUGO GERNSBACK**  
Editor-in-Chief

**KARL E. SCHUBEL**  
Associate Editor

**G. ALIQUO**  
Circulation Manager

**IN THE NEXT ISSUE**  
The January issue will contain the following:

- The "Simplicity—1"

The most unusual Radio receiver ever built, embodying a new radio principle: "CAPIND" tuning.

- Electron Physics
- Record Player Attachments
- Electronic Voltmeters

and a further selection of articles for the

● **RADIO BEGINNER**

Contents **DECEMBER, 1942** Issue

**VOLUME XIV -- NUMBER 3**

Mailbag .....	132
Editorial: Censorship vs. Radio Progress .....	135
The Radio Month in Review .....	136

## SERVICING

Wartime Repair of Radio Components .....	by Fred Shunaman 138
RADIO SERVICE DATA SHEET: No. 328 Radiola 522 .....	140

## WARTIME RADIO

The New Handy-Talkie .....	142
----------------------------	-----

## SOUND

A Semi-Professional Recording System .....	by Paul H. Trautwein 143
Hearing Aids for the Million .....	by C. M. R. Balbi, M.I.E.E. 144
High Efficiency R. F. Amplifiers .....	146

## RADIO INSTRUCTION

Naval Operator School .....	148
-----------------------------	-----

## TEST INSTRUMENTS

A Direct-Reading Ohmmeter .....	by Louis B. Sklar 149
---------------------------------	-----------------------

## ENGINEERING

Seven New Radio Tubes .....	150
Electrical Quantities .....	by Willard Moody 152
Homodyne Reception .....	154
Square Wave Measurements and Their Future .....	by Warren Miller 156
Radio Engineering in the War Effort .....	by Arthur Van Dyck 157

## EXPERIMENTERS

Twenty Ways to Use the "Electric Eye" .....	by C. W. Palmer 161
The Victory Receiver .....	by Isadore Samkofsky 164

## DEPARTMENTS

Mailbag .....	132
The Radio Month in Review .....	136
Servicing Notes .....	135
RADIO SERVICE DATA SHEET (See Servicing) .....	140
Latest Radio Apparatus .....	166
Book Reviews .....	191

## RADIO & TELEVISION

Easy One-Tuber .....	169
Beginner's One-Tube Short-Wave Set .....	by Francis R. Harris 170
Radio Symbols for the Beginner .....	by C. W. Palmer 172
Famous 1-Tube Circuits .....	174
Question Box .....	Edited by Fred Shunaman 176
Radio Hook-ups .....	178
Radio Kinks .....	182

★

Published by Radcraft Publications, Inc. Publication office: 29 Worthington Street, Springfield, Mass. Editorial and Advertising Offices: 25 West Broadway, New York City. Chicago Advertising Office: RADIO-CRAFT, 520 North Michigan Avenue, Chicago, Ill.

RADIO-CRAFT is published monthly, on the first of the month preceding that of date; subscription price is \$2.50 per year in U. S. (In foreign countries, 75c additional per year to cover postage; Canada, 50c additional.) Entered at the post office at Springfield as second-class matter under the act of March 3, 1879. All communications about subscriptions should be addressed to: 29 Worthington Street, Springfield, Mass., or Director of Circulation, 25 West Broadway, New York, N. Y.

★

Foreign Agents:

London—Gorrings American News Agency, 9A Green St., Leicester Square, W. C. 2, England.

Paris—Messageries Dawson, 4 Rue Faubourg, Poissonniere, France.

Melbourne—McGill's Agency, 179 Elizabeth St., Australia.

Dunedin—James Johnston, Ltd., New Zealand.

★

Text and illustrations of this magazine are copyright and must not be reproduced without permission of the copyright owners.

★

Copyright 1942 Radcraft Publications, Inc.

P R E F E R R E D

*for*

P E R F O R M A N C E



R E S I S T O R S

\*"In your opinion, is any particular line of resistors superior to the others?"

This question was put by an independent research organization to a country-wide list of Engineers and Executives in the electronics field. No brand of resistors whatever was mentioned in the questionnaire. Result: *IRC was voted "superior" by more than twice as many as named any other single brand.*



*IRC flies the flag of the  
Army-Navy Production Award*

**INTERNATIONAL RESISTANCE COMPANY**

401 N. BROAD STREET • PHILADELPHIA

# OHMITE

Rheostats • Resistors  
Chokes • Tap Switches

## HELP YOUR WAR EFFORT



**ON THE WAR FRONT**—Many of you now in active service have long been familiar with the dependability of Ohmite Products. When you notice so many of these same units in vital war equipment on land, at sea and in the air, it gives you added assurance and helps you fight a better fight.

**ON THE HOME FRONT**—Here, too, you find innumerable Ohmite Resistance Units in radio, communications and electronic devices, in test apparatus and electrical control equipment. This knowledge helps you do a better job in dealing with today's resistance-control problems or in maintaining the service of existing equipment.



### Send for These Handy Aids

**Ohmite Ohm's Law Calculator**  
Helps you figure ohms, watts, volts, amperes—quickly, easily. All values are direct reading. No slide rule knowledge necessary  $4\frac{1}{2} \times 9$ " Send only 10c in coin to cover handling cost



**Quick-Reference Catalog 18**  
Gives up-to-date information on the wide range of Ohmite Stock resistors, rheostats, chokes and switches used in all types of applications. Write for it now—*it's Free!* Ohmite Jobbers Everywhere

OHMITE MANUFACTURING COMPANY  
4896 Flournoy St., Chicago, U.S.A.

Be Right with **OHMITE**  
RHEOSTATS • RESISTORS • TAP SWITCHES

### RE: AIR-RAID WARNINGS

Dear Editor:

While reading your publication an idea came to me which I would like your opinion on. It concerns air-raid warning by radio using the same idea used in sweep oscillators which is used in aligning radio receivers.

If that same principle were incorporated in the oscillator of a high-powered broadcast station, I believe it would be a very good way to warn people of air raids by radio. I believe it would cover a predetermined range of frequencies simultaneously—like a blanket—therefore, no matter what station you were listening to the warning would be superimposed on the station that a radio listener would be tuned to. Of course, this would interfere with the program on any station within the range, but in an air raid this should not be considered hostile because radio stations should not be operating.

I was wondering if such a transmitter would be against the F.C.C. laws on radio. Of course, I cannot experiment with such a device because I'm in the Army now. Anyway it is an idea and I would like your opinion on it.

PVT. ADAM D. SOARES,  
Alamogordo, N. M.

(The Interceptor Commands have already devised means to shut down broadcasting. This is easier than trying to "blanket" all bands.—Editor)

### COOKE SLIDE RULE

Dear Editor:

In answer to C. McHenry's (of Canon City, Colo.) letter in the October "Mailbag" and your comment thereto regarding the Cooke Radio Slide Rule, to my knowledge this excellent rule has been available since 1939 from Keuffel & Esser Co. of New York, as the sole manufacturing and distributing agents. It is known by the full name of THE COOKE RADIO SLIDE RULE.

However, I regret to inform those interested that unless they are able to run across one in the hands of a retail dealer or have a priority rating of AAA-3 or higher, they will be unable to purchase one. I asked Lt. Cooke regarding this and he said I might inform you that at the present the priority situation is so bad that even he is unable to purchase one of his own rules. However, we do hope that the situation will improve in the next few months.

WALTER NEAL PIKE,  
Washington, D. C.

(This will answer the question that may have arisen in many readers' minds. Undoubtedly the rules will be available after the service branches of the government have been supplied.—Editor)

### SHUNAMAN'S ARTICLE

Dear Editor:

Being a constant reader of your monthly magazine, I have just finished reading Mr. Shunaman's instructions on transformer design. I hope he will keep his promise in reference to another series on this topic.

I hope other Radio-Craft readers will find as much pleasure as I do in reading articles of this nature.

ELMER ROBERTS,  
Toronto, Ontario, Canada.

(We are happy to print another one of Mr. Shunaman's interesting articles in this issue.—Editor.)

### HOW IT ALL STARTS

Dear Editor:

It was in 1933 while waiting at a railroad station that I happened to be introduced to the Gernsback publication, "Short Wave Craft." Although I had made radios as a boy and had studied physics at the university, it was not until I had read a few copies of your magazine that I became aware of the possibilities and interests of radio.

I continued to read and study and soon I had my amateur license. In the due course of time I built up a 500-watt transmitter, talked to eighty some odd countries, and made over 5,000 friends on the air. I sincerely believe that no one could have a more fascinating and wholesome hobby than that of radio.

Although world conditions make it no longer possible to talk by radio-telephone to world-wide friends, I still find interest in the new developments described in your magazine. Also I started to work again on code and with a code speed of 40 w.p.m. I may some day find myself pounding brass for our very good Uncle Sam.

WALTER W. JOHLER, W9UZS,  
Boonville, Missouri.

### INTERESTED IN THE SONOVOX

Dear Editor:

I would like to read about the new radio equipment called the *Sonovox*. I have heard it over the air and have seen and heard it in motion pictures. I enjoy hearing it and would like to know all about it—how it is made and what other uses it has.

PVT. JOSEPH J. CUMMINGS, JR.,  
Ft. Devens, Mass.

(The *Sonovox* is simply a means of picking up the vibrations from the throat of a human being or an animal, amplifying these vibrations and superimposing them upon a sound channel.

Two or one microphones are attached to the *outside* of the throat of the speaker who forms the sounds that are to be recorded on top of another sound record. The result is a weird combination of sounds. Thus a sound recording of a frog's actual croaking can be used. Now if we superimpose appropriate human words upon the frog's croaking, a humorous frog-talk results. The possibilities are endless.—Editor)

### IMPROVING OLD SET

Dear Editor:

Due to the shortage of new radios I am endeavoring to improve the tone of my old set by adding booster circuits and placing the set in a larger acoustically-designed cabinet. I would therefore be very grateful if you could let me know which of your back issues have had good articles on booster circuits and baffles. If it would not be asking too much I should like to know which article is the most easily worked out, efficient and giving the greatest improvement. This last I ask solely because I know little about radio and as a novice would not like to try something too difficult.

DAVID R. LANNING,  
Akron, Ohio.

(Have you tried totally enclosing the speaker, except for a small rectangular opening below the speaker opening? This boosts the "bass" notes in most cases.—Editor)

**ARE YOU ABLE TO SUPPLY THESE?**

Dear Editor:

Through the channels of your Mailbag section I wish to obtain any old battery sets that came out previous to the advent of A. C. sets; also any early A. C. super-heterodynes such as the Lincoln, Scott, etc.; also any apparatus or literature of the same vintage. I am especially interested in obtaining the Stromberg-Carlson Model 601 neutrodyne, treasure chest table model. I use this set constantly (and regardless of all the improvements of the past 17 years), by adding a Jensen dynamic speaker with a 45 to drive it and a fixed crystal in place of the detector grid condenser. This set has a tone quality fully equal to that of many modern sets.

I have done very good DX work also, logging 63 stations on 56 channels. I challenge any serviceman to prove that the quality construction of this set is not excellent even in comparison with many modern sets. Has any *Radio-Craft* reader an instruction manual to this set? I will be willing to pay as much as I can afford to anyone who can help me.

RUSSELL WORTHY,  
Williamstown, Mass.

**INTERESTED IN CONSTRUCTION ARTICLES**

Dear Editor:

I am a regular reader of *Radio-Craft* and particularly like your construction articles. Every now and then I see articles in your magazine about sound film recorders such as the Recordograph, and the Jefferson-Travis film recorder. These film recorders are expensive. Can you tell me where I can get plans for building one of these film recorders? I think a film recorder has many advantages over disc recorders. I would like to see more construction articles in your publication telling how to make devices such as sound-level meters, sound frequency-analyzers, and "alert" receivers. Thank you.

HARRY MORTON,  
Laredo, Texas.

(Perhaps one of our readers could help Mr. Morton.—Editor)

**F-M ADAPTER**

Dear Editor:

I have come upon what can be classed as an idea and a problem. I would appreciate it if some reader will explain if the idea will work.

I think that if such a device could be built for a reasonable sum of money, several uses found for it other than the purpose for which I would use it.

The device I have in mind would consist of a F-M wireless record player followed by a simple F-M adapter, which in turn would be followed by a one tube or two tube amplifier. If this device could be connected in the output circuit of a short-wave receiver, it would cut down the static to such a low level that all signals would come in as clear as most SWL's would like them to. Some one may have thought of the idea before now and given up in disgust but I believe that it will work. What do you think? I would appreciate it if some reader could send me a diagram for a circuit of this type, especially one which could use old tubes such as the 27, 24A, 45, and 47 types.

CARL FISHBACK,  
Hillsboro, Oregon.

**GRID EMISSION**

Dear Editor:

The article entitled "Tracking Down Grid Emission" as published on page 14 of the *Radio-Craft* for October 1942 was very interesting to the reader but I wish to call to your attention some technical errors in this article.

In the last paragraph of the second column on this page in the fourth sentence in this paragraph, it states: "Therefore, it flows through the R.F. coil, through the A.V.C. resistor R, on through the volume control to ground." This statement would be true if you were talking about grid current due to a positive potential on the grid of the tube in respect to cathode. But, since you are talking about grid emission whereas the grid itself is emitting electrons, you have an altogether different case. For instance, let us first take your statement as quoted above and if the current did flow from the grid of the tube through the coil through resistor R and back through the volume control to ground, then the voltage developed across resistor R would be negative on the left side of the resistor and positive on the right side because current always flows from negative to positive. Looking at it in this manner it will be found that you would add bias to the tube rather than subtract bias from it.

I am sure that this should have been stated saying that the electrons emitted from the grid flow to the plate, through the power supply back to ground through the volume control back up through resistor R and through the coil to return to the grid. Now using this explanation whereby the current flows from ground through the volume control (Figure 1) through the resistor R then through the R.F. coil to the grid, it will be found that the left side of the resistor would be positive in respect to ground and therefore this would "buck" the original bias developed across the line control and would cause trouble.

I realize the fact that these errors in various publications do exist and you would like them brought to your attention so that you can make the correction for the benefit of the reader.

GEORGE RISK,  
Omaha, Neb.

(Mr. Risk brings out an interesting point, and we are inclined to agree with him. What do some of our technically-minded readers think?—Editor)

**WANTED: A DIAGRAM**

Dear Editor:

I have been a reader of *Radio-Craft* magazine for the last two years and have found it to be "tops" in every way, especially in the numerous diagrams you have published of experimental units.

There is a diagram of a unit which I have been looking for, for some time, and have not been able to find, and that is a unit similar to the circuit of the Metal and Treasure Locator, but with a much larger radius. I have been experimenting with the circuit of this Locator and have had no luck by changing this circuit around.

I would appreciate it very much if you could give me any help on this matter or by referring me to some company.

D. E. SRESOVICH,  
Jacksonville, Fla.

(Perhaps some of our readers could help Mr. Sresovich. We doubt, however, that there has been produced so far a radio-locator that is effective over a "large" radius—say even one mile.—Editor)



**KEEP 'EM**

**"POUNDING BRASS"**

Put your finger on any important strategic point of today's worldwar map and you'll find one or more American radio operator on the job, "pounding brass" for Victory!

Yes — on the land, on and under the sea, in the air — everywhere radio equipment must be operated with speed, precision, and courage — you'll find Melville-trained men at work! Their outstanding performance is the reason why so many leading airlines of the world look to Melville for new men and women — why the Army, Navy, Marines, Merchant Marine and Coast Guard welcome the cooperation they are getting from Melville. The management of this School is proud of every Melville graduate who is now "doing his stuff" in the service of the United Nations and in Commercial radio aboard ships and planes of the world.

**MELVILLE**

AERONAUTICAL RADIO SCHOOL, INC.  
45 West 45th Street New York City

Training Men & Women for Radio in the Service of  
AIRLINES - ARMY - NAVY - MARINES - MERCHANT  
MARINE - COAST GUARD - INDUSTRY

**NEW CATALOG**

OF SOUND AMPLIFYING SYSTEMS

AUDIOGRAPH Sound Systems represent the latest in Public Address equipment — a complete line plus pre-tested accessories.

**NEW LOWER PRICES**

Outstanding quality and performance at prices that help you meet any competition.

WRITE FOR YOUR FREE COPY

**AUDIOGRAPH**

THE FIRST NAME IN SOUND

John Mack Industries — Liberty at Pennsylvania Ave., Plymouth, Ind.

**LEARN RADIO**

**TELEVISION**

600 LICENSED graduates placed in past 7 years in shipping, broadcasting, aviation, police, etc.; we also teach radio servicing and repairing; new beginners' class now forming; 60-page catalog free; oldest, largest and best equipped.

**MASS. RADIO SCHOOL**

18 BOYLSTON ST., BOSTON, MASS., Est. 1899



**YOU'RE WAY AHEAD OF THE ACTION  
IN THE U.S. ARMY SIGNAL CORPS**

• Some day American voices will rock the Imperial Palace in Tokyo and cause the defenses of Berlin to tremble. They will be the voices of U. S. Army radio men, relaying commands for the final attack. Will yours be one of them?

**I**N THIS fast-moving war, words are weapons. Split-second communications are vital to the timing and teamwork that win battles. As one of Uncle Sam's radio soldiers, you not only see action — you help to guide and direct it!

In Army communications, your opportunities for heroic service are limitless. At the same time, you receive training and experience that will be invaluable for a successful after-the-war career. You learn how to assemble, install and operate the most modern radio transmitters, receivers, "Walkie-Talkies," "Electronic Sentries" and scores of other closely guarded secret devices—pioneers of future industries—which combine today to knit the whole Army into one hard-fighting unit.

Any man, physically fit, from 18 to 44, inclusive, may enlist. Licensed radio operators and radio, telegraph and telephone workers may enlist for active duty at once. They may advance rapidly up to \$138 a month, plus board, shelter and uniforms, as they earn higher technical ratings.

Men of 18 and 19 may choose enlistment in the Signal Corps without any previous training or experience.

Those without qualifying experience, who enroll full time, may enter the Signal Corps Enlisted Reserve for training with pay. Graduate Electrical Engineers may apply for immediate commissions in the Signal Corps.

Civilians over 16 years of age may attend a Signal Corps School, and will be paid not less than \$1020 per year for full-time training and future service with the Signal Corps. Apply U. S. Employment Bureau or U. S. Civil Service.

**"KEEP 'EM FLYING!"**



**U.S. ARMY RECRUITING AND INDUCTION SERVICE**

Visit or write the nearest U. S. Army Recruiting and Induction Station or write to: "The Commanding General," of the Service Command nearest you, or Procurement Branch, AK-2, A.G.O., Washington, D. C.



---

---

# RADIO-CRAFT

Incorporating

RADIO & TELEVISION

---

---

"RADIO'S GREATEST MAGAZINE"

... "Let's not have any more of this nonsense."—

Wendell Willkie ...

## CENSORSHIP VS. RADIO PROGRESS

By the Editor — HUGO GERNSBACK

ONE of the greatest anomalies during modern war is the fact that technical progress is both advanced and retarded. Strange as the statement may sound, it is perfectly true and logical, as the following consideration readily shows

During war time, any progress that has to do with the implements of war and all that goes with it, advances sharply. Developments which normally take decades to achieve, are often compressed into a few months. In war—and particularly in modern, technical war—speed is the paramount factor. At the same time, technical progress, by which war does not benefit, is slowed up and frequently disappears altogether. As our esteemed contemporary, the London WIRELESS WORLD, puts it, "War has a tendency to drive radio progress underground."

No one can find any fault whatsoever that technical progress for war purposes is paramount and that all efforts of all technicians should be bent on concentrating on it. Once the war is won, peace may well take care of itself; so what matters it if a little time is lost in shifting back from the war to the peace effort?

We are, however, very much concerned with censorship which not only drives future peace-time radio progress underground, but also makes it almost impossible for students and others who are just getting started in their technical profession to obtain necessary and often vital information through the press, whether it is a newspaper, weekly or technical magazine.

We have viewed with growing concern for some time the wholly unintelligent and often downright stupid censorship in our own country when it comes to dealing with technical problems. Normally, the censor is not a technician, he knows little or nothing about technical matters and cannot usually distinguish between what is antique, and what is so new that it might be of benefit to the enemy. The technical press is particularly irritated no end with the heavy restraint put upon it; and it becomes most difficult to publish worthwhile technical magazines at all in the United States today. A magazine of standing cannot forever rehash old matter, or print only such irrelevant material that no reader with any intelligence wishes to read. Every editor knows that really new inventions, for the most part, are taboo. The large manufacturing organizations and research laboratories have little worthwhile news to give out today, because they themselves are under a strict censorship. In consequence the technical magazines and the daily press get only a pitifully small amount of worthwhile technical information.

The magazine editor when he is not sure about the status of certain information, is required to submit such material to the censor who often holds it for days and weeks before releasing it.

To be sure, the entire United States Press today is under voluntary censorship; and as far as is known, the technical press to date has not violated the self-imposed trust. Radio magazines, however, appear to be in the most difficult position these days because there is hardly anything published that does not draw the immediate fire of the censors. Radio, admittedly, is one of the major implements of war, which is one reason that

the censor views everything published by the radio press with suspicion and often alarm.

I doubt if there is a single technical editor or publisher in the United States who does not know the difference between military radio and peace-time radio. Admittedly, a radio receiver can be used for both peace and war, but this is begging the question because, after all, we are concerned only with what a potential enemy can use against us, if we made the invention first and, he finding out about it, then turned it against us.

The important point is that technical editors know their business and know exactly how far they can go. The reason is simple; no technical editor worth his salt would long be an editor unless he was internationally minded. Year in and year out, exchange magazines and technical papers in every language flow over his desk. He therefore has a very accurate idea what the enemy already knows and what he doesn't know. Technical progress in such things anyway is usually pretty much an evolutionary and well-ordered process. Radio principles are the same all over the world. Admittedly, there are refinements; admittedly there are also sharp radio advances during war time for war purposes only. These, every editor knows through grapevine channels and he is careful not to publish such information; certainly when it does come to a supposedly revolutionary radio invention, he would be the last one to print it.

But when different censors have different ideas of U. S. censorship and often put publishers to great expense for no sensible reason, this then becomes vicious censorship; and, using Wendell Willkie's words on the subject—and we fully agree with him when he says—"Let's not have any more of this nonsense." For, mind you, there is not just one censor to whom a radio editor, for instance, can go; there is an Army censor, a Navy censor and an Air Corps censor. There is also a general censor and, on top of this, we have an "export" censor.

If these various and assorted censors would concern themselves with new military developments, we would be the last to take issue with them; but when such a censor invokes his ban on ancient material, then such censorship becomes ridiculous.

An example. The November issue of RADIO-CRAFT was two weeks late because a censor in one of the departments of our armed forces insisted upon killing a certain story and a cover picture, after the complete cover for the entire issue of RADIO-CRAFT had been printed, thus creating a great monetary loss to the publisher. And what was the offensive picture and article? A radio device well known to every country all over the world. A device several years old which had been done to death in the radio and technical press in practically every radio and other technical magazine throughout the entire world. An article on this subject numbering several pages ran in 1941 in the *Saturday Evening Post*, which has a circulation of over three million copies a week. The offending picture, incidentally, also ran in the *New York Times* in August of this year. All of this, however, did not deter the censor from insisting that the story

(Continued on page 163)

## A Digest of News Events of Interest to the Radio Craftsman

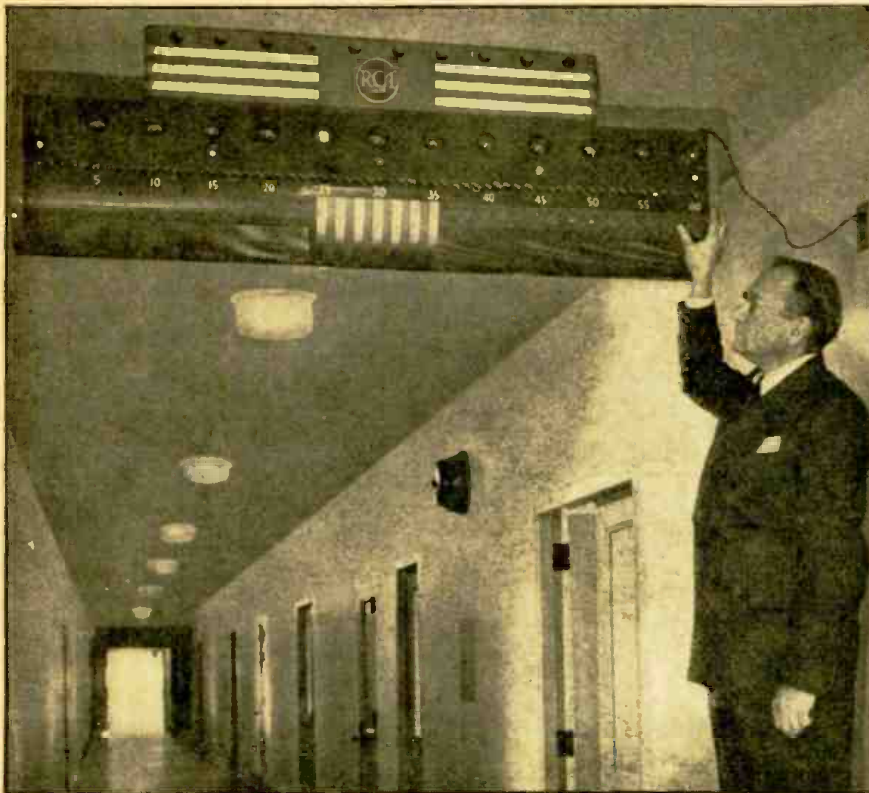

Dr. Zworykin is shown with new electronic clock.

### ELECTRONIC CLOCK

A novel electronic clock is installed in the new RCA Laboratories in Princeton, N. J. This ultra-modern timepiece equipped with more than 170 electronic tubes counts the 60-cycle pulsations of electric current, and indicates that count in terms of seconds, minutes and hours by means of lights. It has no moving parts, no motors, wheels,

main spring or hands. Scientists say it may form the basis of the household clock of the future. Blinking lights "tick off" the seconds on the line shown from 1 to 60, while other lights denote the minutes and hours. Pictured here with the clock is Dr. V. K. Zworykin, Associate Director of RCA Laboratories, who with his staff developed it.

Selective Service Headquarters last month notified local boards of 92 occupations, in the communication services, which are to be considered "critical" when classifying men for the call to arms. The list was issued in accordance with certification by the War Manpower Commission that communication services are essential to the support of war effort.

*Draft deferment of men on this list continues to be at the discretion of the local boards, Selective Service information men emphasized. In general, deferment is determined by the answers to three questions:*

1. Is the man in an essential service?
2. Is his job essential to the functioning of that service?
3. Is he irreplaceable in that job?

The new listing is designed to answer questions 1 and 2.

In classifying registrants employed in these activities, Selective Service Director Hershey said, consideration should be given to the following:

- (a) The training qualification or skill required for the proper discharge of the duties involved in his occupation;
- (b) The training, qualification, or skill of the registrant to engage in his occupation; and
- (c) The availability of persons with his

qualifications or skill, or who can be trained to his qualifications, to replace the registrant and the time in which such replacement can be made.

Here are the communications jobs sets down as "critical":

Accountant, cost; bankman; cable engineer; cable-lay-out man; cable splicer; cable tester; cameraman, newsreel; carpenter, maintenance; central-office installer; combination man, telephone and telegraph; composer operator; compositor; control-room man; control supervisor, junior; control supervisor, senior; cutter, newsreel; cylinder-press man.

Director, international broadcasting; editor, managing; electrician (all around); electroplater; electrotypist; engineer, professional and technical; engraver, lithographic; film editor, newsreel; foreign-language announcer-translator; foreign-language-news-or-script writer; foreman, composing room; foreman, electrical work; foreman, press room; foreman, welder; imposer; instrument maker; jackboard operator; lineman, telephone and telegraph; linotype operator; local-test deskman.

Machinist (all around); make-up man, printing; manager, employment and personnel; manager, production; mechanic, electric maintenance; mechanic, mainte-

### F-M PROGRESS

So far as could be learned, in a recent survey conducted by F-M Broadcasters, Inc., Washington, D. C., none of the operating F-M stations contemplate curtailing their schedules, unless, of course, in order to extend tube life, they reduce their time on the air by having a daily schedule of shorter duration than they would ordinarily have.

Some 28 of the reporting commercial stations maintain full or partial staffs, aside from personnel that also works for affiliated AM (Amplitude Modulation) outlets. It might incidentally be mentioned for those who are statistically minded, that about six F-M stations have no connection with any AM interests, and are operated solely as independent ventures.

The average length of an F-M program day is 10½ hours, ranging from 24-hour service in some areas, to the six-hour minimum that the Federal Communications Commission requires, in others.

It was found that the average F-M program schedule is 73% non-duplicated, in contrast to AM service in the same area. In other words, 73% of the programs planned for F-M transmission are heard only on F-M stations, and not on the AM group.

Some of the F-M broadcasters in certain areas explained that due to incomplete antenna installations or lack of higher wattage transmitters owing to wartime priorities, etc., they are covering only about 60% of their assigned area. This is not so bad, in view of the fact that there are now 37 commercial F-M outlets.

### RADIO OLD-TIMER IN NAVY

An old-time radio man since World War I, Henry A. Hutchins, General Sales Manager of National Union, ever since Pearl Harbor has felt the urge to return to the Naval Service to do his bit.

He is now Lieutenant Commander Hutchins, U. S. Naval Reserve, on active duty.

Every radio man who knows and respects "Hutch" also knows that he will do a swell job wherever he is.

## CRITICAL COMMUNICATIONS JOBS

nance; mechanic, mechanical tabulating equipment; mechanic, radio communication office; monotype-keyboard operator; offset-press man; overlay cutter.

Photocomposing-machine operator; photoengraver; photolithographer; photoradio operator; platen-press operator; power-house engineer; press operator, cylinder; press-plate maker; printer (all around); private-branch-exchange installer; private-branch-exchange repairman; production man, bilingual; program-transmission supervisor; radio operator; radio repairman, broadcasting; recording engineer; rigger, radio.

Sound engineer, newsreel; station installer; station repairman; stencil operator, photographic stercotyper (all around); telegraph operator; telegraph-repeater installer; telephone inspector; telephone-plant powerman; telephone station installation supervisor; telephone-switchboard repairman; teletype installer; teletype repairman; tester, transmitter; testing-and-regulating man.

Toll-line repairman; toll-office repairman; tool maker; traffic chief, radio communications; transferrer, hand; transformer repairman; translator; transmission engineer; war correspondent; web-press man; welder (all around); wire chief.

**NEW F-M STATIONS**

Station KYW of Philadelphia announced last month that its F-M affiliate, W57PH, is now on the air on regular schedule.

This brings up to five, the number of commercial F-M stations in Philadelphia, which means that this city has more F-M service than any other city in the U. S., except New York City.

Station WMBI in Chicago also announced last month that W75C will start broadcasting programs soon. This station being owned by the Moody Bible Institute will be the first non-commercial F-M transmitter, with religious programs being the feature.

For the duration the power will be limited to 1000 watts, because material of that size is on hand. The station is using an ST link (studio-to-transmitter radio beam) instead of the usual telephone wire connection, the first in Chicago to do so.

New York City now has nine F-M stations, since W75NY, constructed by Metropolitan Television, Inc., controlled by two New York Department stores, went on the air last month, as did W39NY, owned by the City of New York. This latter station, of course, will be non-commercial.

**STATION KFAR IS REOPENED**

Reopening of Station KFAR at Fairbanks, Alaska, last month, on 5000 watts established a new frontier broadcaster of radio programs at a point close to the top of the world.

Installation of the new equipment was signaled by an NBC coast-to-coast broadcast originating at KFAR, celebrated throughout Alaska as establishing an important link between the Territory and the folks "back home in the States."

Alaskans have been clamoring for a long time for a stronger broadcasting service. It took Pearl Harbor, however, to emphasize the fact that it was a military necessity. In the week following that event, KFAR was the only station on the air in Alaska. It was also the only Alaska station on the air during and after the bombing of Dutch Harbor last June. Since Fairbanks is in the interior of Alaska, it was able to reach most of this territory's population.

The increase of the station's output from 1000 to 5000 watts demonstrated how the Army, other governmental agencies and industry can cooperate in slashing red tape and finding short cuts, when a specific need becomes urgent. It was shown that the station was the only means by which military authorities could reach the population with instructions in case of emergency.

In record breaking time an entirely new transmission plant, including the famous RCA type 5-DX broadcast transmitter, was conjured out of the RCA plant, with WPB approval, tested and tried by company engineers and delivered to the transmitter house a few miles outside of Fairbanks. Just two months and thirteen days later it went on the air. Moreover, the installation was made without disturbing daylight programs over the old 1,000 watt equipment, which was an RCA type 1-G broadcast transmitter. In the meantime the old plant was dismantled, moved and reassembled at night, while the new equipment was being installed.

KFAR's first transmitter was built in 1939 by Stanton D. Bennett, then only 23 years old, but already a veteran in radio installation and operation. He is now Chief Engineer of the station, in which post he designed the layout in conjunction with RCA engineers.

**CHINESE ENGINEER AIDS WAR WORK**



Dr. Chao-Chen Wang, 28-year-old Chinese engineer, is doing his "Jap fighting" in an electronics laboratory of the Westinghouse Electric and Manufacturing Company. By designing high power radio tubes for the armed forces of the United Nations, the young scientist is contributing to ultimate Chinese victory.

Enlisted for the duration of the war as a member of America's production army, Dr. Chao-Chen Wang, 28-year-old Chinese design engineer is at work in the electronics laboratory of the Westinghouse Electric and Manufacturing Company, designing high-power radio tubes which he believes will contribute to the ultimate Chinese victory. He has little doubt about the outcome of the war; he feels that China will keep fighting until the Japanese are driven back to Japan.

The young Chinese scientist studied electrical engineering at Chiao Tung University in Shanghai and was sent to the United States in 1937 by the Chinese Government on a university scholarship. He specialized in ultra-high-frequency communications at Harvard University, receiving his Master's degree in 1938, and his Doctor's degree in 1940.

Since joining the Westinghouse electron-

ics staff four months ago, the tall Chinese engineer has submitted two patentable disclosures, covering new developments in the electronics field. One describes a method for measuring power output of high-frequency radio tubes, that is designed to improve production of communication apparatus for the United Nations. Westinghouse officials said they planned to put this method into operation shortly.

Enthusiastic about the work he is doing; Dr. Wang is convinced that the great strides now being made in electronics for military purposes also will be an important factor in promoting a lasting peace after the war. These developments will be important in expanding China industrially and in breaking down the misunderstandings that have surrounded China for centuries.

Although he is anxious to return to China to see his family again, Dr. Wang intends to remain on his war job for the duration.

**"THIS IS A RADIO WAR"**

At a War Workers' Rally staged by the Radio Corporation of America employees at Camden, N. J., September 13th, Colonel David Sarnoff, President of the R.C.A. and now on active duty in the Office of the Chief Signal Officer, made some pointed remarks. Among others, Mr. Sarnoff stated:

"This is a radio war. The troops on the ground, the sailors on the high seas, the pilots in the air all depend on radio for their success and for their safety. Millions of men in uniform look to you to supply them with the fastest means of communication the human mind has been able to conceive.

"The deathless courage of our men on the fighting front will win this war," he said. "But they depend on an equal cour-

age on the home front. You have always got to remember that the stuff you turn out today, instead of tomorrow, can mean the difference between life and death to some American boy on a ship, or in a plane, or on a field of battle.

"In the past you have helped to put the United States out in front of all other nations in the fascinating field of radio. You did that in the days of peace; but our enemies say you cannot do it in time of war. They say that when it comes to war, we are slow, and soft, and inefficient. They say they can beat us because what we can do is going to be in their judgment 'too little, and too late.' That is a lie, and you and I know it.

"Every man and woman in this industry has a production job to do."

Here's another interesting article by Mr. Shunaman on how to repair parts which are vitally needed in making replacements in existing receivers. Experimenters and set constructors will find this article of value as much as the serviceman will.

# WARTIME REPAIR OF RADIO COMPONENTS

By FRED SHUNAMAN

**T**HE repairman in the basement below me has solved the scarcity problem. "I have just sent 42 cards to customers—told them to come and get their sets," he said. Unable to get replacements, he took the radio version of "the easiest way out." Some servicemen have to stay in business, so this system cannot be universally recommended. Defective parts formerly thrown away, can be—and now must be—repaired. Or else.

Power transformers were dealt with in the previous two articles. Filter chokes, audio and output transformers can now be handled in the same way, if certain precautions are taken.

## FILTER CHOKE COILS

The *air gap* is the critical thing in a filter choke. You have noted that the power transformer laminations are interleaved to provide an uninterrupted path for the magnetic flux. In the choke there is a definite and intentional break in this path. You will find all the "E" pieces put in from one side, all the butt pieces from the other, and often a piece of paper or press-board between the two. (Fig. 1). This is to provide a

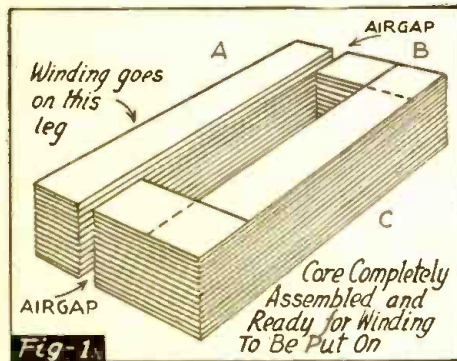

"gap" in the iron path of magnetism. These gaps are of a very definite width, and vary according to the size of the choke and the job it has to do. Preserve the piece of press board, or measure carefully the gap width, then proceed to wind the choke the same as a transformer. When finished, make sure the gap is exactly as before, and everything should perform correctly.

Small chokes used in midget sets are simply wound like a spool of thread, with no insulating paper between layers; no definite layers in fact. These are the easiest of all to wind. The number of turns is by no means critical, and they often work well if wound with wire a size larger than that in the original winding. A coil-winder with a step-up ratio, or a power drive is needed for these coils—they have too many turns for straight hand winding.

## AUDIO TRANSFORMERS

Often the first and worst trouble with these is to get at them! In some of the oldest models, the transformer was evidently put into place—then the set built around it. When you do get it, it will be in a box of pitch, often with some other component.

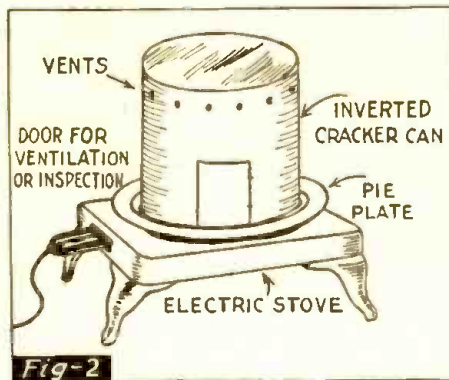

The pitch can be conveniently melted out in a melter made out of a tin pie-plate and a cracker tin mounted over an electric stove. (See Fig. 2.) A few holes help ventilation and prevent the temperature from rising too fast. The trick is to get everything just hot enough to flow off the pitch without damaging the insulation. After most of the compound has run off, the transformer can be pulled out. The laminations are removed and put to soak in a can of kerosene while the windings are examined.

Audio troubles are usually in the primary winding. This is almost always inside the secondary. It is often possible—by using extreme care—to push the primary right out while it's hot and the insulating compound still liquid. (If you like clean work, get a job in the bank!) Try to leave the paper which separates the two windings, intact, and do all the damage to primary which is being removed. Once out, put it on the winder and count the turns. The new winding must be very carefully made so that it won't be too big to slip back inside the secondary, Fig. 3.

Some Class-B transformers have the primary on the outside, and a few have it in two sections, side by side. A prod to the center connection and an ohmmeter will tell you which half must come off and be re-wound. This job is fairly easy—Class-B transformers have fewer turns and bigger wire than their Class-A cousins, Fig. 4.

Many audio transformers have their windings impregnated with paraffine wax. This is not recommended to the serviceman, unless he can be absolutely sure of the purity of the wax. Acid in ordinary paraffine eats

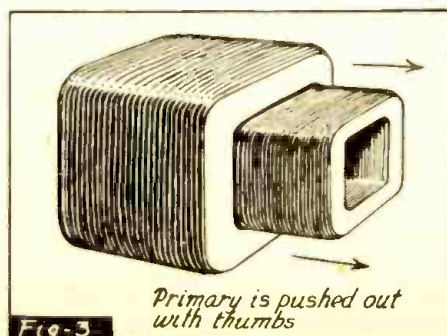

through the fine wires in a month or so, and there is another breakdown. Insulating varnish is all right, and cellulose lacquers can be used safely on all windings expected to remain cool.

## LOUDSPEAKERS

All loudspeaker trouble is divided into three parts: cone, including voice coil; output transformer; and field coil. Of all these the field is easiest to handle. This coil is almost invariably wound on a spool, and you have only to unwind it, keeping a sharp lookout for the bad place—manifested by a burned area or the presence of "green spots." The bad wire is thrown away and the unwinding continued to be sure there are no more "green spots," for these corroded places are usually found near the core. If the wire has been corroded where it touches the cardboard spool, either make a new one or soak it well in insulating varnish and let it dry thoroughly. Then wind the good wire back again, using extra wire from other junked apparatus if necessary.

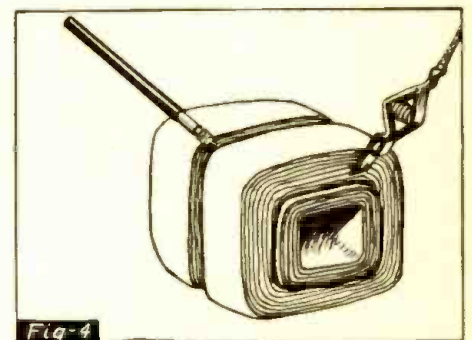

Many large speakers are bolted together, making it very easy to take out the field coil. Most small ones have a frame into which the field is inserted before the center core is put in. To get the field out of these, lay the speaker face down on a solid bench or floor, and—using a good-sized hammer and a punch with a wide face—drive out the center piece. (Better take the cone off first.) Try to drive it out with one blow. When the coil is repaired it is replaced and the core driven carefully back in. Use a wooden mallet, or a piece of wood under the hammer, to avoid damaging the part inside the voice coil. It should center itself properly.

Certain Philco speakers are put together with a special screw which looks impossible to remove, but which can be driven back readily with a hammer and punch. Many of the very old large RCA speakers are welded together, and can be taken apart only with a hack-saw.

Burned-out transformers are possibly the commonest of speaker troubles. The output transformer is the easiest of all to wind, and should give little trouble even to the beginner. Only one precaution is necessary; use exactly the same number of turns on primary and secondary as the manufacturer did.

Voice-coil repairs are not so easy. One

## Servicing Notes

### Trouble in . . .

#### STROMBERG CARLSON 935

This set and other Stromberg Carlson made in the last few years using dual .05 condensers invariably develop a short in the I.F. by-pass section of dual condenser, causing the one thousand ohm resistance to smoke.

#### 1942 RCA RADIOS

These sets develop shorts in the .0035 condensers connected from plate to ground of output tubes occasionally burning out the output transformer.

#### MOTOROLAS WITH BALLAST TUBES 61E, 62E, 63E

These sets will hum a trifle; or increase in hum when volume is increased. Also there is distortion. The No. 1 pin of the L49B Ballast tube is grounded to the chassis. If the ballast tube touches the metal shield, this becomes the point where the hum and distortion originate. The trouble usually is not noticed until the volume is nearly full. Remedy—Replace the ballast tube. If a new one is not obtainable as ballast tubes are quite scarce now, unsolder No. 1 pin from the chassis. You will find the receiver works OK.

H. RAY BOYER,  
San Angelo, Texas.

#### RCA RADIOS

Practically all radios incorporating power transformers and coming into the shop for the first time have wads of sealing compound accumulated underneath the power transformer. This seems to be excess compound and melts and runs out as the transformer heats. This compound has a high melting point and can be put to the following use: Nearly all RCA radios use the crimped end paper case type of tubular condensers that are not sealed and sooner or later they start giving trouble by opening up. Most cases of such opens are due to the fact that the condensers are mounted with a tension between the two leads. I have found that 9 out of 10 of these condensers can be permanently repaired against opening up by carefully removing the condenser and while pushing the leads back into the case and against the ends of the coil, run some of the above sealing in the ends of the case. The compound can be melted and run into the case with a hot soldering iron. Allow it to harden well before reinstalling. P.S. DON'T CHARGE THE CUSTOMER WITH A NEW CONDENSER WHEN YOU DO THIS AS IT CONSTITUTES A REPAIR.

PAGE'S RADIO SERVICE.

#### ZENITH 7S487

Set plays weakly. Look for shorted .05 condenser from B+ return of second I.F. to ground.

#### ZENITH 10S589

Phono arm does not finish complete cycle due to improper adjustment. To remedy, turn clutch adjusting-screw D.P. one-half turn.

#### ZENITH 8S443

Local stations received very strong but distant stations weak. Look for a partial short of .05 condenser bypassing screen of 1232 R.F. tube.

#### SILVERTONE 4462

Set plays intermittently. All tubes test okay, and voltage is okay. Change the 6B5.  
LAWRENCE ROESHOT,  
Wilkes-Barre, Pa.

trouble—the loose or rattling voice coil—is easily handled with thinned-down radio cement or Duco. Well-thinned insulating varnish works well, if given plenty of time to dry. Use gentle heat from an electric light bulb and leave it for a day or so. Many cases of open voice coil will be found to be at the connection between the lead and the coil itself. Such breaks are easily soldered. An attempt to wind the voice coil is at best a mean job, and is often unsuccessful. The clearance between voice coil and core is too small to leave any margin for lack of skill.

*Radio-Craft* for June, 1942, carries on Page 591 an item on making new cones. I never tried it, but it seems feasible. The radioman already knows how to handle cracks, warped voice coils and tears, but it is harmless to point out that where the crack is small, a coat of thinned cement along it is better than a patch, as a smaller area of the cone will be stiffened.

### R. F. COILS

A very complete set of articles by Lawrence V. Sorensen on servicing R. F., I. F. and oscillator coils was printed in the June, July, August and September issues of *Radio-Craft* for 1940. These called in many cases for replacement with ready-made units which may not now be available. Even so, the articles may profitably be re-read for an understanding of the technique employed. The primary windings are the ones that go out, due to high voltage and the resulting electrolytic action when moisture gets in.

Single-layer windings, as on most broadcast and all short-wave primaries, can be rewound by hand. All that's necessary is to wind the same number of turns of the same size wire into the same space as the old coil occupied, and the set will never know the difference. Universal-wound primaries and I. F. coils often go at the joints or near the ends, because of corrosion from the air, the form or the flux used in soldering. It's a good idea to unwind a couple of dozen turns to see if the break appears. If not, it's probably at the other end, and there is nothing to do but replace the coil or the transformer.

In extreme cases, universal-wound coils—even tuned I. F. coils—can be layer-wound. Put the form on a winder and wind on layers of the same width as the original coil. Wind on the same number of turns as was on the original—inserting paper between each layer, as when winding a transformer—and the coil will have much the same shape and size as its predecessor. The distributed capacity will be much greater, and it may be necessary to take off turns to make it tune properly.

If you have to replace an I. F. transformer, try to get one as much like it as possible. If the set has one I. F. stage, the transformer is probably a high-gain type, and the replacement should also come out of a set with one I. F. stage. Check the resistance of the windings with a low-range ohmmeter, to make sure the replacement is in good condition. If you have a cathode-ray oscillograph, it is a simple matter to replace an I. F. primary coil. If not, you are likely to run into difficulties, for small differences in the coils and coupling have large effects.

In all work with R. F., I. F. and oscillator coils, one rule is all-important. *Write it down!* Make sketches of everything—spacing between coils, lugs terminating each coil, spacing of wires, number of turns, direction of turns, and everything else. With complete sketches and notes, the repair and

replacing of an all-wave oscillator coil is not too hard. Without them, you can get into trouble on a simple I. F. primary. See Fig. 5.

It is not widely known (though mentioned in a recent *Radio-Craft*) that resistance-capacity coupling can be used to bridge burned-out I. F. primaries, as well as those in audio

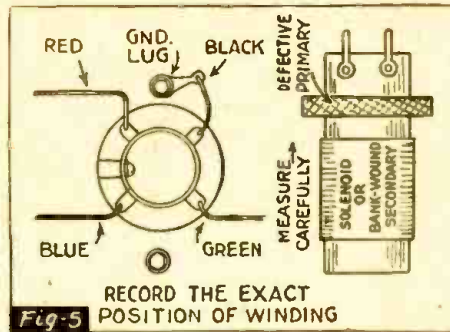

transformers. (Fig. 6). Sometimes it is necessary only to attach a resistor from the plate to plus-B to get results, the primary coil having enough capacity to the secondary to pass signals. This stunt should never be used as a repair, but is good when making

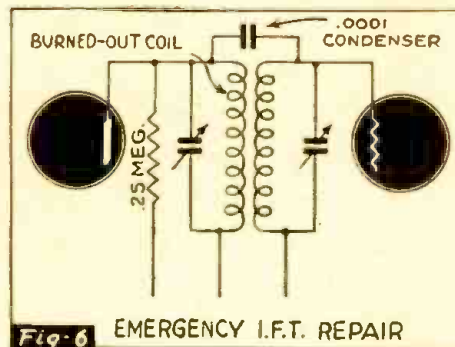

an estimate, as the receiver can be put into operation and faults found in other circuits.

### VOLUME CONTROLS

The best thing to do with volume controls is—nothing. Most of them fail because the carbon strip has been burned or cracked, and attempts to "repair" with India ink or soft lead pencil usually result in the set getting worse than ever in altogether too short a time. In a few cases a comparatively new control will become noisy because of loose carbon on the resistance strip. These cases can be treated by carefully brushing off the strip. A loose arm can also cause noise, which disappears when the arm is tightened. The method depends on the volume control itself. In some types the only way is to slip a thin brass shim (cut to shape) between the split ring on the shaft and the sleeve.

### FIXED CONDENSERS

Only when electrolytics and large paper condensers become entirely unobtainable will I attempt to repair them—however, some good suggestions along that line appeared in Homer C. Buc's article in the June, '42 *Radio-Craft*, together with a few good hints on cleaning up Litz-wound coils.

As the Serviceman's resources dwindle, his resourcefulness will increase, and a year from now he will be doing things which today he would not believe possible. There is little reason for believing—with my basement-shop friend—that the servicing profession is finished as soon as it becomes impossible to buy a phono-radio switch.

**RADIOLA 522**  
**Five-Tube Single-Band AC-DC Superheterodyne Receiver**  
**with Built-in Loop Antenna**

1st PRODUCTION: CHASSIS NO. RC-1001C  
 2nd PRODUCTION: CHASSIS NO. RC-1022A

**ALIGNMENT PROCEDURE**

**Output Meter Alignment.**—If this method is used connect the meter across the voice coil, and turn the receiver volume control to maximum.

**Electronic Voltmeter.**—The electronic voltmeter in the Chanalyst or VoltOhmyst provides an unexcelled output indicator. It should be connected to the AVC bus.

**Test-Oscillator.**—Connect the low side of the test-oscillator to the receiver chassis through a .01 mfd. capacitor. When the electronic voltmeter is used as an alignment indicator the output of the test oscillator should be adjusted to produce several volts of AVC. With the output meter alignment method the oscillator output should be kept as low as possible.

**Calibration Scale.**—The glass tuning dial may be easily removed from the cabinet and temporarily attached to the dial backing plate for quick reference during alignment.



**SPECIFICATIONS**

Frequency Range—540-1,720 kc  
 Intermediate Frequency—455 kc  
 Loudspeaker—5-inch Electrodynamic  
 Power Supply Ratings—105-125 volts, 50-60 cycles, A.C. or D.C.—25 watts

**DETAILS OF ALIGNMENT PROCEDURE**

**Step No. 1.**—Connect the high sides of test oscillator to 12SK7 grid in series with 1.0 mfd. condenser. Tune it to 455 kc. Turn radio dial to a quiet point near the 1,600 kc. end. Adjust the 2nd I.F. trimmers, C10 and C9, for maximum output.

**Step No. 2.**—Connect the high side of test oscillator to the 12SA7 grid in series with the same capacity. With the test oscillator and receiver at the same settings, adjust C8 and C7 of the first I.F. transformer.

**Step No. 3.**—Attach the high side of the oscillator to the antenna terminal of antenna transformer in series with 200 mmfd. Tune the oscillator to 1,720 kc. and tune the receiver dial to the same reading. Adjust the oscillator trimmer, C14, for maximum output.

**Step No. 4.**—Set the test oscillator to radiate a signal at 1,300 kc. Turn radio dial to resonance on signal. Adjust for maximum output the antenna trimmer, C15. Repeat steps 3 and 4, carefully readjusting C14 and C15.

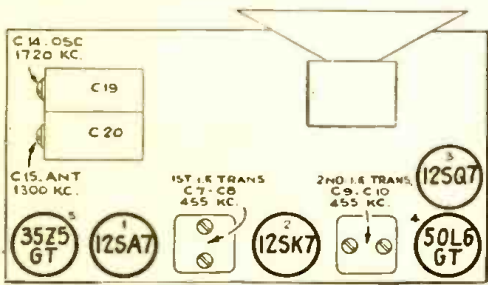
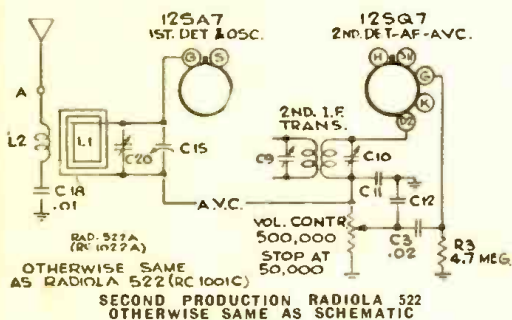

**CHASSIS LAYOUT**

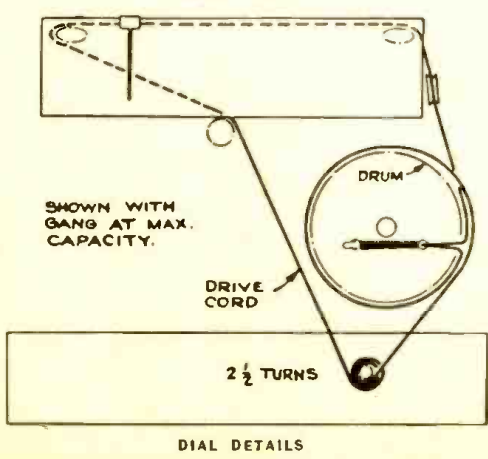

**DIAL DETAILS**

**PARTS LIST**

**CHASSIS ASSEMBLIES**  
 1st Prod. (RC1001C)  
 2nd Prod. (RC1022A)

- Board—Terminal board and receptacle (RC1001C only)
- Capacitor—Comprising one section of .005 mfd., and one section of .0003 mfd.
- Capacitor—Electrolytic comprising 1 section of 20 mfd., 150 volts and 1 section of 30 mfd., 150 volts
- Capacitor—.01 mfd., 1,000 volts (RC-1001C only)
- Capacitor—.01 mfd. (RC1022A only)
- Capacitor—.02 mfd., 700 volts
- Capacitor—.035 mfd., 400 volts
- Capacitor—.05 mfd., 400 volts
- Capacitor—.01 mfd., 200 volts (RC1001C only)
- Capacitor—.01 mfd. (RC1022A only)
- Coil—Oscillator coil
- Condenser—Variable tuning condenser
- Control—Volume control and power switch
- Cord—Drive cord (approx. 33-in. overall length)
- Indicator—Station selector indicator
- Loop—Antenna loop (RC1001C only)
- Loop—Antenna loop (RC1022A only)
- Plate—Dial back plate complete with drive cord pulleys less dial
- Pulley—Drive cord pulley
- Resistor—120 ohms, 1/4 watt
- Resistor—22,000 ohms, 1/4 watt
- Resistor—220,000 ohms, 1/4 watt
- Resistor—470,000 ohms, 1/4 watt
- Resistor—3.3 megohm, 1/4 watt
- Resistor—4.7 megohm, 1/4 watt
- Shaft—Tuning knob shaft

- Socket—Dial lamp socket
- Socket—Tube socket, moulded
- Socket—Tube socket, wafer
- Spring—Drive cord spring
- Transformer—First I.F. transformer
- Transformer—Second I.F. transformer
- Transformer—Loop coupling transformer (RC1001C only)
- Transformer—Speaker transformer
- Washer—"C" washer for tuning knob shaft

**SPEAKER ASSEMBLIES**  
 (RL-86B-1)

- Cap—Dust cap
- Coil—Field coil, 350 ohms
- Cone—Cone complete with voice coil (RL-86B-4)
- Cap—Dust cap
- Coil—Field coil, 350 ohms
- Cone—Cone complete with voice coil (92379-1)
- Coil—Field coil, 350 ohms
- Cone—Cone complete with voice coil

**NOTE:** If the stamping on speaker in instrument does not agree with above speaker number, order replacement parts by referring to model number of instrument, number stamped on speaker, and full description of part required.

**MISCELLANEOUS ASSEMBLIES**

- Back—Cabinet back (RC1001C only)
- Back—Cabinet back (RC1022A only)
- Dial—Glass dial scale
- Feet—Rubber feet—Pkg. of 4
- Knob—Control knob
- Lamp—Dial lamp
- Spring—Retaining spring for knob

**NOTE: 35Z5 BURNOUTS**

Experience has shown that oftentimes a receiver is "dead" and the trouble found to be a burnout 35Z5 rectifier. This is due to the fact that the pilot light is in parallel with a portion of the 35Z5 heater circuit. When the pilot light burns out its current passes through the heater section of the 35Z5 and overloads it. Eventually this

leads to burnout of the heater. A suggested remedy is to place a 300-ohm 1-watt resistor in shunt with a single pilot lamp No. 47, or No. 40. If no pilot lamps are used, an 800-ohm 1-watt resistor should be hooked up in shunt with the tapped section of the 35Z5 heater.

Radio Service Data Sheet

328

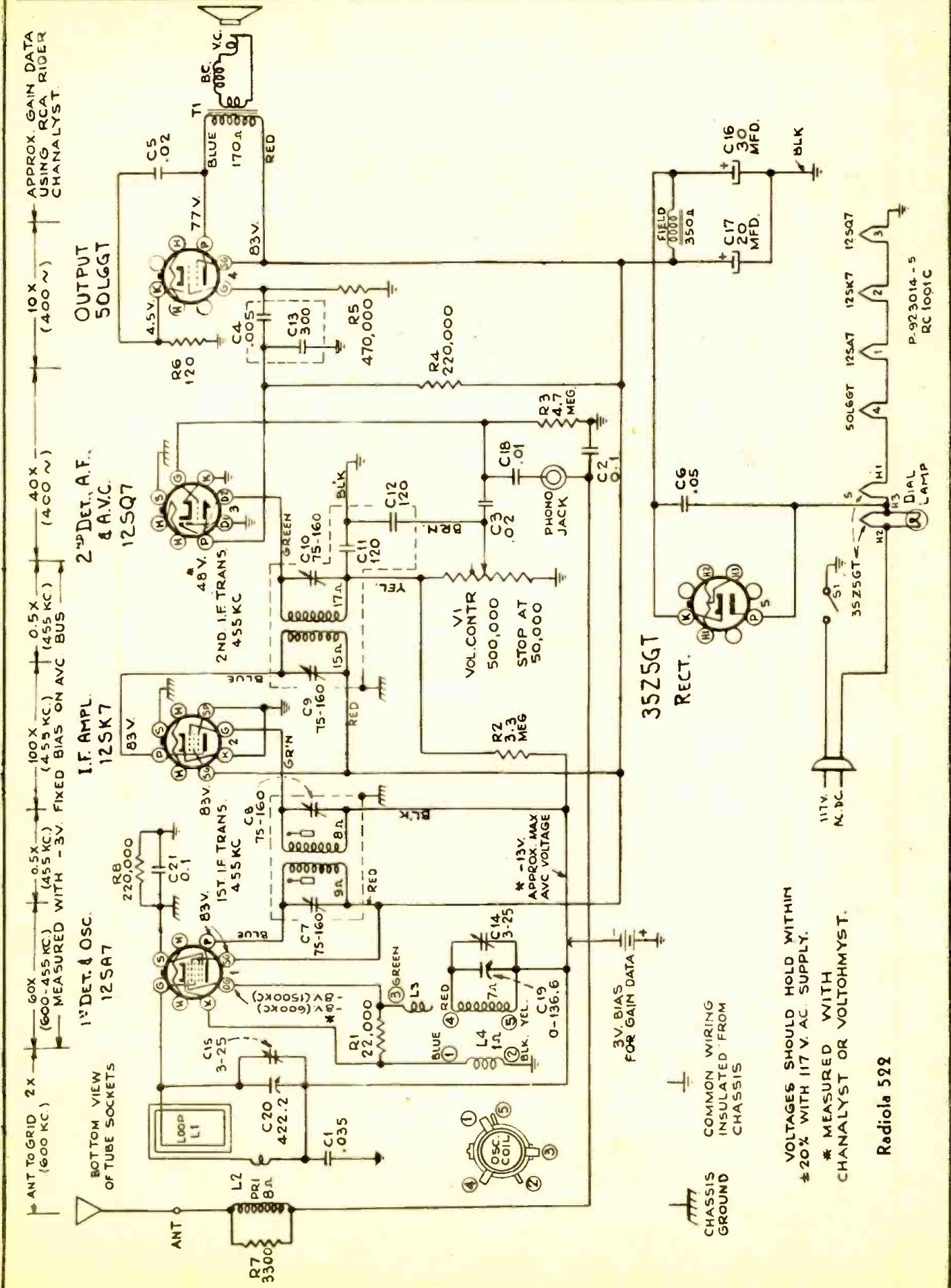

# THE NEW HANDY-TALKIE

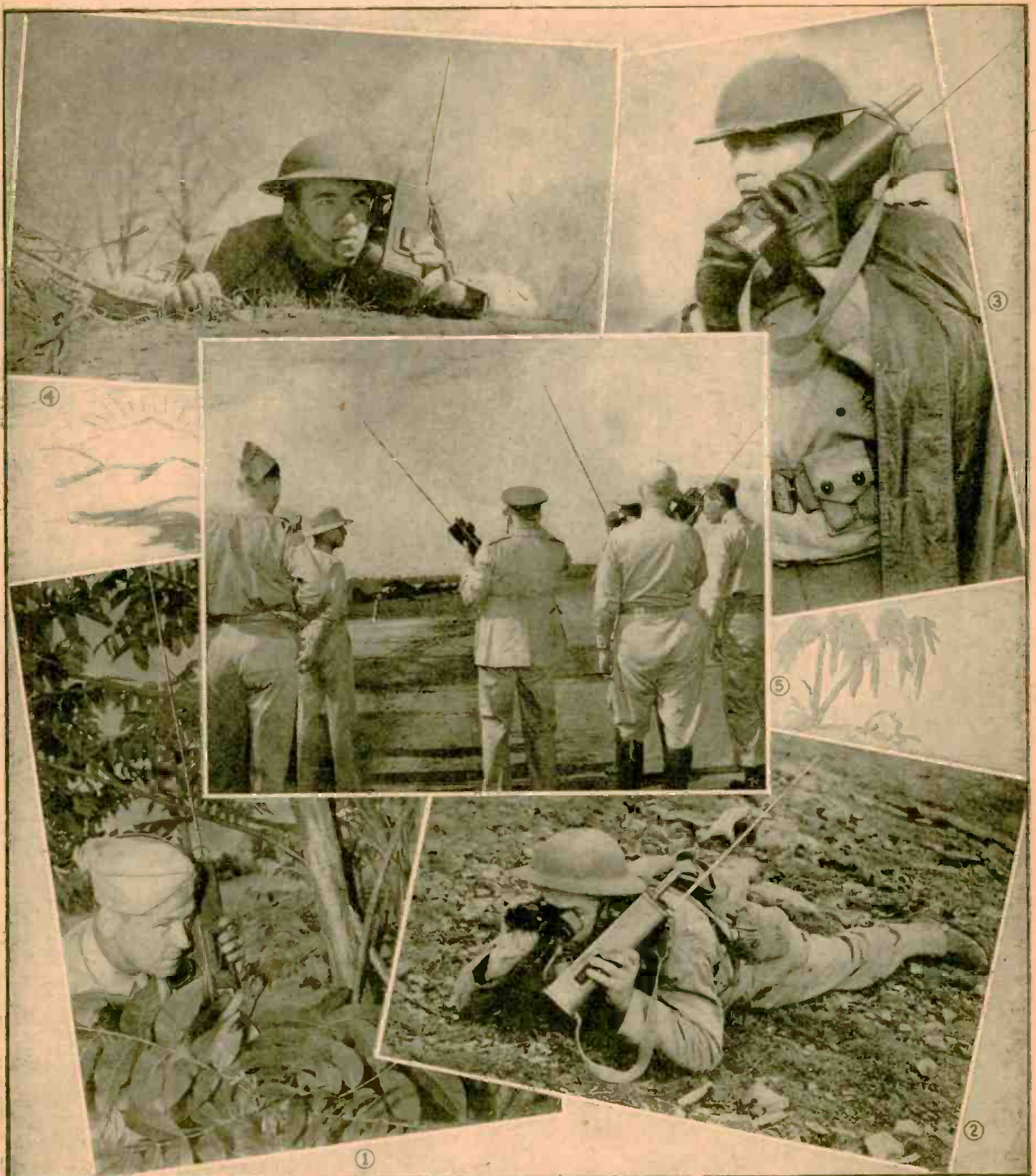

1—Staff Sergeant Thomas W. Gloystein is shown in the field with the new portable hand voice set. He was formerly a fireman in Cincinnati, Ohio, and is now an instructor of Radio Communication at Fort Benning, Georgia. 2—An American soldier with the latest field transceiver used by forward observation patrols. 3—Another view of an American soldier in the field with the new type transceiver used by forward observation patrols. 4—The newest product of the Army Signal Corps—a hand-set radio receiver and transmitter combined into a small, compact portable unit, is shown in action. The antenna telescopes into the back of the set when it is "off the air." The soldier switches from receiving to the sending position by pushing a "push-to-talk" button under his fingertips. This set has been informally named the "handy-talkie." 5—Visiting generals witness paratroops mass jump exercises at Lawson Field during their stay at Fort Benning, Georgia.



# A SEMI-PROFESSIONAL RECORDING SYSTEM

By PAUL H. TRAUTWEIN

**S**INCE the Federal Communications Commission closed down on all "hamming," amateurs everywhere who feel this forces them to look to other phases of radio for a hobby do so with a certain amount of skepticism. It seems that only a few hams realize the amount of fun to be had with a simple home recording system, or the pleasure to be derived in building and operating a recorder of the semi-professional type.

## CHOOSING THE AMPLIFIER

Let us attack the problem of a suitable recording amplifier first. A recording amplifier should have a maximum undistorted power output of at least ten watts. The reason for this is that the impedance of the cutting head will vary with the different voice frequencies. At one frequency the impedance of the cutting head may match that of the output transformer, while at another frequency, it may not. If an amplifier is used which has more power than is actually needed, and this extra power is used for operating a monitor speaker, or simply dissipated in an equalizing circuit, distortion in the final recordings will be minimized.

For instance, if a crystal cutter is used, an inductance can be added which would tend to make the overall impedance have a flatter characteristic throughout the audio frequency range. The amplifier to be described makes use of a monitor speaker to use some of the extra audio power. After these adjustments are made, the amplifier is flat within 1 db. from 50 to 11,000 cycles. Driven by a good broadcast tuner, or F-M converter, the amplifier is capable of turning out some first-class recordings.

It is not within the scope of this article to enter upon a complete discussion of the relative merits of constant-amplitude vs. constant-velocity recordings. But, to assist the uninitiated, it might be explained that a constant amplitude recording is one where in the displacement of the cutting stylus is uniform for a given signal voltage, no matter what the frequency affecting the cutting head is; and a constant velocity recording is one where the displacement of the cutting head varies inversely with the frequency affecting the cutting head. Because low-frequency signals would cause a large movement of the stylus (and possibly cross-cutting of adjacent grooves), some form of constant amplitude response is always used below a frequency of 500 cycles. Therefore, the term "constant velocity" applies only to frequencies above 500 cycles.

## CONSTRUCTION OF AMPLIFIER

Looking at the amplifier. Fig. 1, from left



to right, the controls are, amplifier power-switch, record-speaker switch, tone control,

*For the "ham" who has been looking for something to turn to, now that amateur transmitting is prohibited for the duration, here's an excellent idea. By rebuilding his speech amplifier, or other good 20-watt amplifier, he can experiment with home recording, which in itself can be a full-time hobby.*

low-gain channel volume control, and switch for magnetic pickup or microphone. On the far left is a jack for the speaker or earphones, and on the extreme right are the low gain channel jack, and the microphone connector. In the center is to be seen the Volume Level meter, to indicate the proper sound level. The meter will register on Record only—not on playback. On top of the chassis, near the mike connector, is a small jack for the magnetic pickup. The output transformer, filter condensers, and fuse, are mounted on top of the chassis. Underneath the chassis, in the lower left-hand corner is a shield for the microphone connector. The chokes are mounted beneath the chassis, near the power transformer.

## CUTTING HEAD

The cutting head should be of the magnetic type, of proper impedance to match the secondary of the output transformer (in this case 500 ohms). There are several types of mountings for the cutting head. The best type is the lathe type mounting, which is usually very expensive. An excellent compromise is found in the overhead-feed mounting, Fig. 2, which is swiveled to



the center of the turntable when recording. It is advisable to buy the type of cutter which is so constructed that the angle of the cutting stylus can be adjusted. However, it is essential that the weight of the cutting head be changeable.

## MOTOR

The motor should have enough power to turn the turn table at an even speed. This can be tested by actually cutting a record with an audio tone being recorded. (Station WWV is good for this purpose). If the motor is too weak, "wows" will result. Wows are usually indicated by a wavering reproduction, when the recording is played back and are most troublesome when musical recordings are being made.

The turntable should have a drive-pin one inch from the center shaft, to prevent the recording disc from slipping on the turntable. The motor and turntable should be mounted on a heavy stand, or in the top of a heavy table, to prevent vibrations from being carried into the recording. It is well to mount the motor with rubber washers

and padding to insulate it mechanically from the stand.

## STYLI AND NEEDLES

Now for the needles: Steel cutting styli are the least expensive on a first cost basis, and are to be preferred when there is danger of the stylus being damaged. Steel styli cost 15c to 75c each, and have a useful life of about thirty minutes. For the first few minutes of cutting, they are virtually as quiet as a sapphire, but after repeated cuts they get more and more noisy. They must be discarded after thirty minutes.

The cutting needle should always be at right angles to the record. Careful tests made by recording experts over a long period of time, show that trick cutting-angles are of use only when some defect is present in the cutting head, or in the stylus itself.

## BLANKS AND DISCS

The quality of the blank disc will have an important bearing on the fidelity of the recording. If the surface of the blank is too hard, the thread will be powdery and tend to roughen up the groove as it is cut. If a paper-base disc is used, the high-frequency response will drop off above 4000 cycles. Although these are not as satisfactory as the glass, aluminum, and steel base discs, the bond-base discs are good for speech recordings and incidental recordings. The best type of lacquer coating is the nitrate of cellulose ("acetate") coating. The slow-burning coated blanks are usually too soft, and not at all suited to good recordings.

A good blank will be perfectly flat, and have a smooth, uniform coating that is not mottled with "orange peel." Any bumps or visible imperfections in the coating indicate that the blank is not of the highest quality. Most manufacturers endeavor to keep the characteristics of a certain brand of blank as uniform as possible, so by using as few types as practicable, the number of necessary changes to be made in the depths of cut can be minimized. During recording, the shavings from the groove should be about the thickness of a coarse hair. (When the cutting depth is about 0.003 inch).

When recording at 33 1-3 r. p. m., care

Turntable Speed 78 r.p.m.		
Disc Dia.	PLAYING TIME	
	[96 lines per inch]	[112 lines per inch]
6"	1 1/4 mins.	1 1/2 mins.
6 1/2"	2 mins.	2 1/4 mins.
8"	2 1/2 mins.	3 mins.
10"	3 3/4 mins.	4 1/2 mins.
12"	5 mins.	5 3/4 mins.
Turntable Speed 33 1/3 r.p.m.		
12"	7 1/4 mins.	8 mins.
13 1/4"	9 mins.	10 mins.
16"	13 mins.	15 mins.

FIG. 3

must be taken not to cut too near the center of the blank, as a loss in the "highs" results.

Figure 3 shows the maximum recording times for different diameter blanks. They allow for keeping safely away from the center of the disc.

# HEARING AIDS FOR THE MILLION

By C. M. R. BALBI, M.I.E.E.

*The author, who was for many years Honorary Electrical Consultant to the (British) National Institute for the Deaf, urges that all deaf persons should be given the benefit of mass-production of instruments. He believes that the radio industry is best qualified to manufacture the aids.*



Component parts of a portable hearing aid.

ONE of the effects of war is to drive scientific development underground. But, judging from the last war, every technique undergoes some change during its period of hibernation. It is therefore of some interest to speculate on possible post-war lines of development of the hearing aid.

Those who have been closely connected with hearing aids observed with interest the attention that was being paid by the radio industry in 1939 to the technical developments of the various accessories connected with these instruments, such as tubes and batteries. Further, certain radio manufacturers had themselves marketed instruments for sale to the public, both direct and through the trade. No doubt this would have been extended as the demand grew, but the development would have been gradual, as the radio dealers already had a surfeit of regular lines to handle. Moreover, apparently no manufacturer thought it worth while to launch a national advertising campaign to make the general public hearing-aid minded.

After the war the vast hearing-aid market will no doubt appeal to a number of manufacturers as a possible extension of their activities, and so the views of one who has had a long-standing interest in the subject may prove of interest to both public and manufacturer alike.

The present position regarding hearing aids is not unlike that of the broadcast receiver of the early days. If we look back to the years immediately preceding the war we find that the retail price of a radio broadcast receiver of good performance was stabilized between \$35 and \$50. But this was not always so; some fifteen years earlier, 2-tube receivers were being sold at \$150, with loud speaker extra.

The technical advances made and the low price reached were possible because manufacturers set out to cater for the million. We may ask why the hearing aid, which follows miniature radio receiver practice so closely, has remained so long in the state of expensive individual production. The hasty observer invariably replies that it is because the commercial field is so limited, compared with that of radio, but certain experts consider the hearing-aid market is the bigger of the two. Statistics are not available as to the number of deaf people in existence, but the *British Medical Journal* quotes a figure of six and a half millions in Great Britain as having impaired hearing. This is considered to be a very conservative estimate. A well-known doctor

once put the matter far more convincingly when he said that there were as many people in need of a hearing aid as were wearing glasses.

Now I do not want people to think that there is a market waiting for six and a half million hearing aids without qualification. If spectacles were as clumsy as telescopes to wear, no matter how efficient in restoring correct vision such instruments were, the market would be strictly limited.

Every factor has a bearing on the matter, particularly weight, size, efficiency, simplicity, cost and upkeep. My object is to indicate that the obstacles which have pre-

vented mass production have now been overcome.

It can be said that the purpose of a hearing aid is to restore acuity to normal when deafness occurs, but it is known that nothing less than a laboratory amplifying system of large size and considerable cost will achieve this; therefore, all deaf aids fail in their purpose in a greater or less degree.

Recently this general statement has been expressed in scientific terms which enables us to assess or predict the benefit to be derived from any aid in relation to a person's deafness. When the results are expressed graphically, as in Fig. 1, the fact emerges that with the best kind of radio tube-type hearing aid, a very close approximation to normal hearing can be obtained with at least ninety per cent. of deaf people, but previous types of instrument fell short of this by varying degrees.

The trumpet of about 1910 was light, simple and inexpensive, and helped at long range, but only for the slightly deaf, as it had very little amplification. The micro-telephone of circa 1920 was powerful, but only efficient at short range. The tube-aid which graduated from the carbon microphone (1932) to the piezo-electric instrument (1936), with a corresponding advance in efficiency, has culminated in a design which is highly compact, simple, and efficient to use. Such a design can be seen in the accompanying photographs.

From the foregoing it can be observed how the increase of efficiency has also increased the scope and usefulness of these instruments as designs advanced. The early aids only served the few, while the present type has an extended range which suits the many and by experience is found to assist ninety per cent. of deaf people.

The graphs of Fig. 2 show how public demand (British) has risen with increase of efficiency and in spite of high prices. The matter is of interest as it indicates the trend of future demand.

It is to be remembered that the number of people using hearing aids is a mere fraction of the potential total that it would reach if the price was in the region of, say, \$15 to \$20. This price, of course, can only be achieved by mass production.

Technically, we are not far from the ideal aimed at, and the ninety per cent. coverage which it embraces is sufficient justification for the public to demand revolutionary methods in marketing and service.

The prototype illustrated has three stages

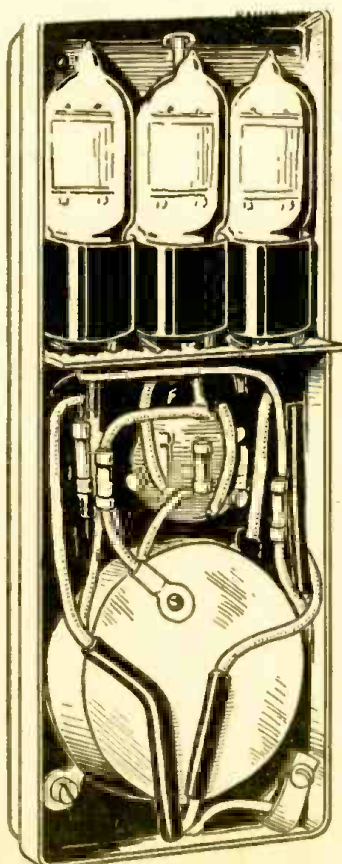

The above illustration shows how the tubes and components are mounted inside the hearing aid. It is the prototype of an instrument designed by the author for large-scale production. It measures 5 1/2 inches by 2 1/4 inches by 3/4 inches.

of amplification, and with the special type of radio tubes now available a speech output of about sixty milliwatts can be obtained from a small B-battery of under forty volts combined in a single unit with a 1½-volt dry cell.

The size and weight of the complete instrument has been reduced to a degree where it has become unobtrusive, and the user can get accustomed to the instrument without noticing any encumbrance; hence we have arrived at the point where it only

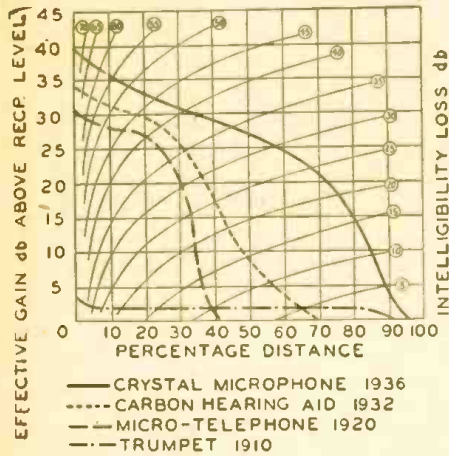

Fig. 1. Chart for predicting the effectiveness of hearing aids of various types. Note how the crystal microphone has the greatest effectiveness, thereby extending the use of hearing aids to those who are almost totally deaf. Even the microphone of 1920 was far superior to the 1910 ear-trumpet.

remains for a change of policy to convert a high-priced article produced on a small scale into a world-wide commodity within the reach of every deaf person. How this will be accomplished depends only on the views of the different manufacturers, but the writer is certain that it will be a radio manufacturer.

There is every indication of support from the medical profession for an improved in-

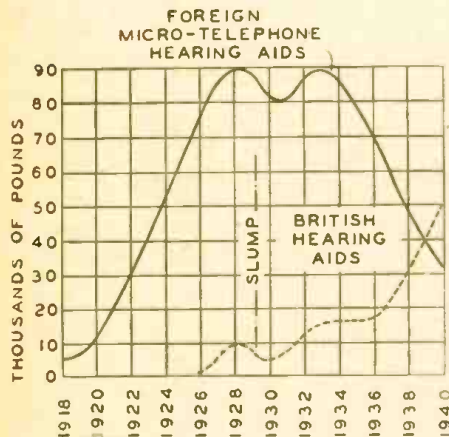

Fig. 2. Showing increase in the sales of hearing aids. The chart shows "pounds" and to find equivalent dollar value multiply by 3. It should also be noted that the falling off in sales from 1934 is opposite to American experience, where sales have steadily increased.

strument at a low price. Only an established service like the radio industry could offer it at a really popular price, but it must be remembered that the radio industry is far from being hearing-aid minded, and that it will undoubtedly remain in this state unless publicity in all its forms are concentrated in bringing this new service to reality.

—Wireless World (London)

### VANITY CASE HEARING AID

A boon to the hard-of-hearing who want to hear clearly when they go to the movies, is a hearing aid mounted in a vanity case, put out by the Volfair Laboratories. The top photo shows the aid in use when seated in the theatre. The center photo shows upper part of the case containing the vanity tray and cigarette case. The bottom photo shows the "mike" mounted in the reflector for maximum effectiveness. Batteries and amplifier are mounted inside and on the bottom of the case.



### RADIO HEARING LAMP

A radio which will find wide use among persons hard-of-hearing is a new product of the Volfair Research Laboratories. It is ingeniously built into a lamp base and thereby constitutes an inconspicuous but very convenient hearing-aid.

The radio has no loudspeaker, as it is not necessary. The output is intended solely for the one person using the device, and therefore is equipped for inserting tips from the leads of a bone-conduction unit, or other usual electric hearing device.

Also, in case the person using the outfit wants to listen to special records or acoustic-treatment recordings, he or she may do so simply by plugging in the leads from the phono player in the proper phone input tip jacks provided.

The accompanying illustration shows the device in use. Note that in general it appears rather inconspicuous, the design of the lamp matching the appearance of the usual table lamp.

The base of the lamp, housing the radio set, is substantially constructed to reduce vibration and microphonics, and is provided with the usual tuning and volume controls.

One advantage of course, of a device of this kind, is the fact that it enables the deaf person to hear all the programs he or she desires, at the volume level that is comfortable and understandable, without conflict with others in the room.

The remainder of the household does not have to be annoyed by having the usual radio turned up to full volume, and often uncomfortable volume, in order that the deaf person may hear it.



Above—Vanity Hearing Aid

Below—Radio Hearing Lamp



# HIGH EFFICIENCY R.F. AMPLIFIERS

THE principal advantage of the class-B linear r.f. amplifier, shown in Figure 1, is the ease with which it may be applied to a radio transmitter to amplify a modulated signal. An output amplifier of this type enables modulation to be carried out in one of the lower-powered stages, where less audio power is required, and provides a simple means of increasing the power output of an existing transmitter.

The principal advantage of the grid-modulated r.f. amplifier is likewise its economy of audio power. The modulating voltage being applied, in this case in series with the d.c. bias and r.f. excitation voltages, the audio power required for complete modulation is negligible compared to that required for complete plate modulation of the same amplifier.

The principal disadvantage of both types of amplifier has been the reduced power output resulting from the conventional methods of operation. To understand the reasons for this reduction in output, let us investigate the manner in which the linear amplifier is generally operated.

## CLASS-B OPERATION

The grids of the class-B r.f. tubes are biased approximately to cut-off, since it is at this particular point of operation along the  $E_g-I_p$  characteristic that the fundamental component of r.f. current is closely proportional to the r.f. grid voltage, a condition necessary for high-quality amplification. The plate current wave is then in phase with the r.f. grid voltage. The r.f. component of plate voltage, on the other hand, describes a wave, the half cycles of which extend above and below a line established by the d.c. plate voltage value, and is  $180^\circ$  out of phase with the r.f. grid voltage. The plate voltage phase is determined by the tuned coupling circuit which is anti-resonant at the fundamental operating frequency. The plate current flows only during positive half-cycles of r.f. grid voltage as a result of the adjustment of the bias voltage to cut-off. These relations are shown in Figure 2.

Because of the phase relationships between r.f. plate voltage and r.f. plate current, maximum plate current is seen to flow at the instant of minimum plate voltage. Conversely, plate current is zero when the plate voltage wave is at its peak. Large amplitudes of the plate voltage wave mean low negative swings. The lower these negative peaks, the lower will be the product

$E_p I_p$ , expressing the plate power loss in the tubes, and the higher will be the amplifier efficiency. The efficiency of the conventional class-B linear amplifier is thus very closely proportional to the r.f. plate voltage amplitude, and it is evident that instantaneous increases in plate voltage level during amplitude modulation give rise to increased efficiencies.

The process of amplitude modulation may produce large plate voltage amplitudes with negative peaks far enough below the zero axis for instantaneous efficiencies between 60 and 70 percent, when the grid excitation voltage is modulated. For 100% modulation, however, the unmodulated plate voltage amplitude must not exceed one half the modulated amplitude. The unmodulated efficiency of the amplifier is consequently only half the theoretical possible value, or 30 to 35 percent. Even under these conditions, the *effective efficiency* taken over the entire modulation cycle has been found to be only fifty percent or thereabouts.

In the class-B r.f. amplifier, the unmodulated amplitude of r.f. plate voltage is reduced to half the modulated value by lowering the r.f. grid voltage to 50% of the value required for maximum antenna current (or maximum r.f. plate voltage). At this point, the power output is one fourth of the theoretical maximum.

The r.f. plate voltage and antenna current increase linearly with the excitation voltage in a class-B r.f. amplifier until the tubes reach the point of saturation determined by their cathode emission. After this point is passed, both the r.f. voltage and antenna current depart from linearity, further increases in excitation voltage resulting in little, and finally no further increase in either plate voltage or antenna current. (See Figure 3.) If the r.f. grid voltage has been adjusted to give an unmodulated r.f. plate voltage amplitude at or near the saturation value, and modulation is then applied, there can be no further increase in either the plate voltage or antenna current amplitudes, but a decrease (negative swing) may still be obtained on negative modulation peaks. As a result, positive peaks of the carrier current and voltage (and plate voltage) will be flattened off, or distorted, at the saturation level, while the negative peaks may remain quite normal in shape. A means of supplying the missing positive peaks would enable operation of the amplifier at high levels of zero-modulation efficiency and increased overall efficiency.

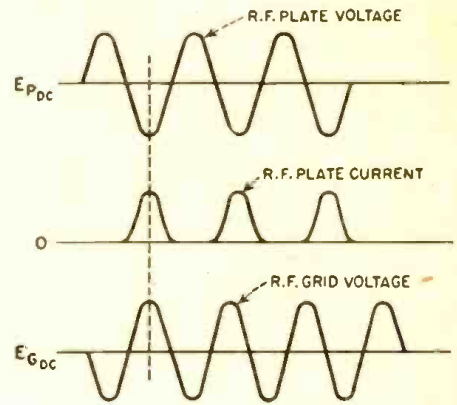

FIG. 2

## THE DOHERTY HIGH-EFFICIENCY AMPLIFIER

In the circuit developed by W. H. Doherty of Bell Telephone Laboratories, two amplifier tubes are assigned different functions. One is operated at maximum efficiency to deliver a high value of resting carrier, while the other comes into operation automatically, as will be shown, to supply the r.f. plate voltage peaks which the first tube is incapable of developing. In consequence of their functions, these tubes are designated *carrier tube* and *peak tube*, respectively.

The skeleton circuit of Figure 4 shows the arrangement of components for accomplishing this action. The two tubes are as-

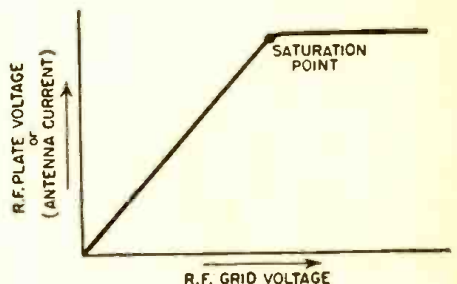
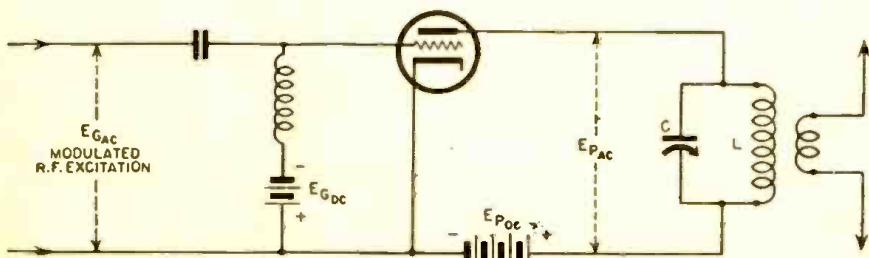

FIG. 3

sumed to have identical electrical characteristics and to receive r.f. excitation from a common source. The load impedance, represented by the pure resistance,  $R$ , diagrammatically represents the conventional tuned coupling circuit through which the amplifier delivers output power.

The peak tube works directly into the load impedance, while the carrier tube has a radio-frequency filter network ( $L-C_1-C_2$ ) interposed between its plate and the load. This network is electrically identical with a *quarter-wave transmission line* and like that device possesses the property of impedance inversion. That is to say, the impedance exhibited at one end of the network is inversely proportional to that measured at the other end. Thus, if the load impedance is  $R$  ohms, the carrier tube plate "sees"  $1/R$  ohms.

The d.c. grid bias of the peak tube is of high value, in order that plate current flow through that tube will be checked at all



CLASS-B LINEAR AMPLIFIER

Tube views tuned coupling circuit as pure resistance when L-C is tuned to antenna. L-C combination has maximum impedance in carrier channel; low impedance for higher and lower frequencies. Hence  $E_{pac}$  is very nearly sinusoidal.

FIG. 1

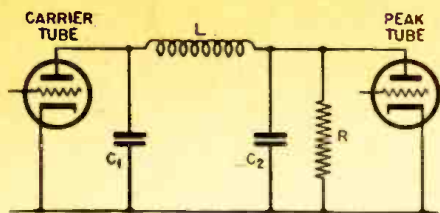

FIG. 4

ordinary values of r.f. grid voltage. The carrier tube bias, on the other hand, is adjusted to cut-off so that that tube operates at maximum efficiency.

If the excitation is increased uniformly from zero, the carrier tube output delivered to R through the network will increase linearly until plate-circuit saturation is reached, whereupon it will level off at a constant value for any further increase in excitation. Meanwhile, a high value of bias has delayed operation of the peak tube. As excitation is increased beyond the point of carrier tube saturation, the effect of this bias is overcome, and the peak tube begins to deliver power to the load along with the carrier tube. The initiation of operation of the peak tube effectively increases the impedance terminating the network. Through the impedance-inverting property of the latter, the impedance presented to the plate of the carrier tube is decreased. This permits the power output of that tube to increase still further without any increase in its alternating plate voltage. Further increase in excitation causes the peak tube to contribute still more power to the load, at the same time permitting the carrier tube output to increase simultaneously. The final result of this action is that, at the instantaneous value of plate voltage amplitude corresponding to the modulation peak, the

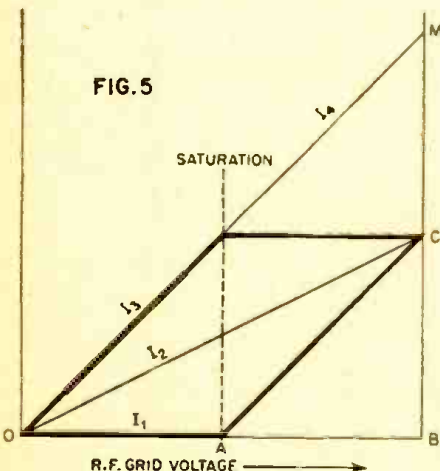

FIG. 5

- $I_1$  = Peak tube-to-load current.
- $I_2$  = Carrier tube-to-network current.
- $I_3$  = Network-to-load current.
- $I_4$  = Total load current.

carrier tube delivers twice its original output power at no increase in output voltage. Half the power in the load is at that instant being furnished by the peak tube.

A graphical clarification of this action is given by Figure 5. As the r.f. grid voltage increases during the modulation cycle, the amplitude of r.f. current delivered by the carrier tube to the load through the network increases linearly from point O until the grid voltage reaches point A, corresponding to saturation. This is the resting carrier point. At this point, this current ceases to increase with the grid voltage and extends along a flat line to axis B at point C.

Meanwhile, the peak tube has been in-

operative for all values of r.f. grid voltage up to point A. After the excitation voltage has passed this point, however, (such as during the modulation cycle), the amplitude of current delivered to the load by the peak tube then increases linearly, as indicated by the lowermost curve, extending uniformly to line B at point C.

The current delivered to the load by the peak tube thus increases from zero at the resting carrier point to a value beyond the carrier amplitude equal to the network-to-load current. This condition of peak amplitude equal to twice the resting carrier amplitude is given by the total length of the curve OM and is the well-known condition of 100 percent modulation.

remain constant while antenna voltage and plate current are permitted to vary. In addition to this function, the peak tube also supplies additional power during positive modulation peaks in the manner already described for the high-efficiency linear amplifier.

The two tubes are separately biased.  $E_{g1}$  and  $E_{g2}$  are so chosen in magnitude that both carrier and peak tubes operate as class-C amplifiers with high plate-circuit efficiency. However, the peak tube bias is maintained at a higher level than that of the carrier tube, so that the former tube is inoperative between zero and maximum resting carrier level. The peak tube is automatically brought into operation when the car-

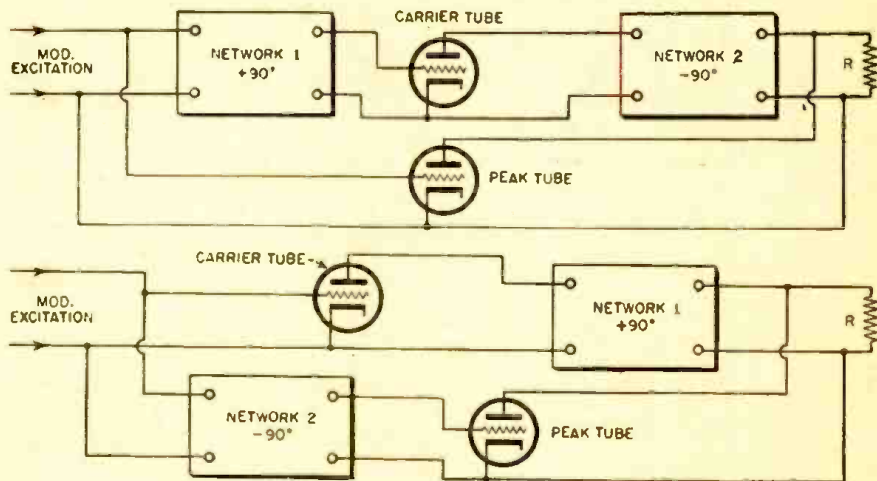

FIG. 6

A by-product of the network action is the introduction of a  $90^\circ$  phase shift. This is not aimed at in the design but is an inherent property of the network as an impedance-inverting device. It is necessary to take this phase shift into account when a high-efficiency amplifier is laid out, since both tubes are to be driven from the same r.f. exciter. A second network must be introduced into the grid circuit of either one of the tubes, as shown in the alternative schemes in Figure 6, to secure the proper plate and grid phase relationships.

Doherty has given 62 percent as the overall efficiency of an experimental high-efficiency amplifier designed for a 1-kilowatt carrier.

TERMAN-WOODYARD AMPLIFIER

F. L. Terman and J. R. Woodyard have made use of the impedance-inverting network just described in their development of a high-efficiency grid-modulated amplifier operating along the same lines.

In this amplifier, carrier and peak tubes are employed in the same functions as in the Doherty circuit. A network equivalent to a quarter-wave line (see L-C<sub>1</sub>-C<sub>2</sub> in Figure 7), together with the peak tube, acts as a variable impedance into which the carrier tube operates. With this arrangement, as with the high-efficiency linear amplifier, the r.f. voltage of the carrier tube is allowed to

reach maximum carrier output level; and then delivers its full output to the load, at the same time increasing the apparent load resistance presented to the network output. The alteration of the load resistance simultaneously permits the carrier tube to deliver still further output power to the load.

In the high-efficiency grid-modulated amplifier, modulating voltage of the same phase is applied to both grids, as shown in Figure 7. However, the voltage applied to the peak tube must, because of the high bias on this tube, be of a larger order of magnitude than that applied to the carrier tube. It has been recommended that this double-voltage audio driving be accomplished simply by supplying the separate tubes from taps on the audio coupling transformer.

The presence of the impedance-inverting network in the plate circuit of the carrier tube introduces here as well a  $90^\circ$  phase shift and, as a result, an auxiliary network of similar electrical characteristics must be inserted into one of the grid circuits to correct the phase of the unmodulated r.f. excitation voltage.

The designers of the high-efficiency grid-modulated circuit state 65 to 80 percent as efficiencies obtainable with this arrangement during both modulated and unmodulated intervals.—Engineering Department, Acrovox Corporation.

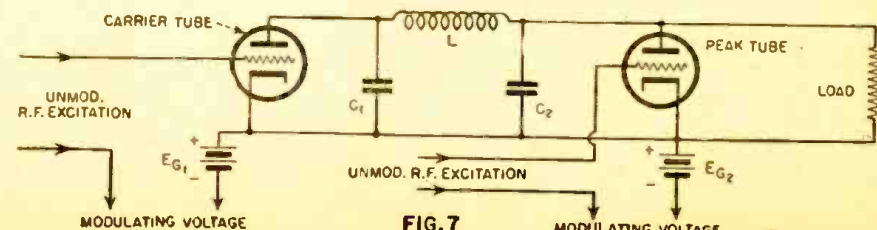
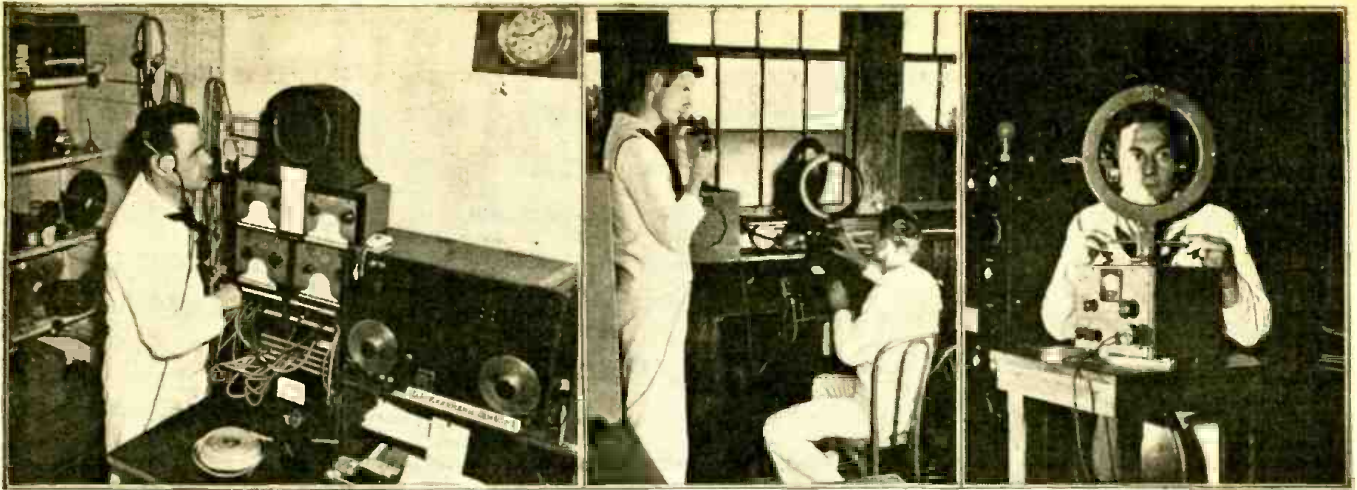

FIG. 7

## • RADIO INSTRUCTION •



Left—Master sending set where code is transmitted to classrooms and recorded by students. Roll of tape in foreground bears code letters punched through it. When run through sending machine, the holes actuate the dots and dashes of the code. Center—Students using a radio direction finder in the airplane detection station atop the barracks building. Right—Student using radio direction finder in the Materiel Laboratory.

# NAVAL OPERATOR SCHOOL

IN the midst of the bombing and fighting at Pearl Harbor that launched the United States on its second World War, the lone radioman stuck to his key. This young radioman had been graduated from the U. S. Naval Training School at Noroton Heights, Connecticut, only a few weeks before. He was new to the sea, but not to the traditions of the sea. He stuck to his post doing his job and it was a good job. He downed no enemy planes, nor won any medals, but he functioned as an integral part of a great fighting machine.

Word of this man's actions came back to the Naval Reserve Radio School and 600 student enlisted men and 100 student officers threw out their chests and stepped with a pace more brisk. They went back into the classrooms, where headsets clattered with code, eager to get to sea themselves. That eagerness permeates the entire institution, which, until two years ago was an old soldiers' home. Each man wants to see action, to get in blows at the Axis, and each man knows that there is no way to do this for him but to master code, visual blinkers, semaphore and International flag code.

The director of this school—the Navy's largest radio instructing institution—is Captain William Baggaley, USN (Ret.), a veteran officer whose sole desire is to turn out communications men and officers as fast—or faster—as there are ships to take them to sea. He has arranged a stiff curriculum. The enlisted men are fresh from "boot school"—one of the recruit training stations

at Newport, Norfolk or Great Lakes. In four months they must master their job and there is no time to waste.

Headphones on, they sit for hours in the classrooms, listening to the sound of dots and dashes. Slow at first, then ever faster, the coded messages come at them from a tape running through a sending machine. Finally the messages are fired at them with the same speed an old radioman would use in transmitting orders from flagship to man o'war in the midst of battle.

When the first classes opened at Noroton Heights most of the students were radio "hams" or amateurs, well versed in code sending. But soon the supply was exhausted and now the future "sparks" will be drawn from the various walks of life. The instructors say a man's background has little bearing on his proficiency. Butcher, baker or candle-stick maker; if he wants to be a good radioman there is nothing to stop him.

Up at 6:30 in the morning, the students move from one class to another to the music of martial airs played over a loudspeaker. Recorded music over an amplifier lends zip to their spirit and military bearing. Classes last until 4:15 in the afternoon, after which there is compulsory drill, exercise and some athletic competitions in which each man must compete. After an evening of study and review they are ready to turn in.

Twice a week movies or a USO show relieves the tension, and Saturday afternoon until Sunday evening constitutes liberty. Students with the wherewithal head for New York.

The drive to get into active service is so intense that many of the men return to classrooms after the day's work is done, to brush up on their sending or receiving.

On clear days they work with semaphore flags, and with International code flags on a mast erected in the school yard. At other times they work with light blinkers and with the blinker gun, which looks like a gangster's weapon, but is only a long hollow tube with a light set deep in the recess. If units of a fleet were operating at night and wished to communicate with one another the signalmen would merely aim the blinker gun at the bridge of the other ship and send out dots and dashes by pulling on the trigger. Because the blinker gun can be aimed so accurately no other person, not in direct line, can see the message flashed.

There are a few telephones at the school but inter-office communication is done with telegraph instruments. If the head of the code section wishes to communicate to the duty officer he taps out the message in Morse code on his desk sender.

Each class is larger now than the one that went before it, and the radio school now ranks as the second largest Naval school in the country. Expansion has not impaired the output. Captain Baggaley sees to that.

"Almost without exception," said the captain, "every man passing through here has a deep incentive to learn to do his job. The reports of the men who have gone out, like the radioman at Pearl Harbor, proved that they are making the grade."

## PRE-SERVICE SIGNAL CORPS MEN GRADUATE

LAST month four hundred thirty men who will call signals for the strongest team in the world, received certificates upon completion of training at Illinois Institute of Technology, Chicago.

They are officers and enlisted reserves in the U. S. Signal Corps who have been trained as ultra-high frequency radio engineers, electronics experts, and radio technicians and mechanics, in an intensive training school conducted by Illinois Tech for the Signal Corps.

Dr. J. E. Hobson, director of the Institute's department of electrical engineering and administrator of the entire radio training program, presented certificates to the men. He also presided at the program, introducing the various speakers.

The graduating men included 35 commissioned officers and 89 enlisted men who have finished the training in ultra-high-frequency techniques, which is the basis for much of the Signal Corps' most advanced equipment. They will enter active

service immediately and commence basic training and special studies.

The remainder of the group (120 men in electronics training and 186 radio technicians and mechanics), will go on to more advanced work, while the rest will enter active service.

Although the Institute has been training men for the Signal Corps ever since that branch of the Service began its expansion program, this was the first formal graduation program.

# A DIRECT-READING OHMMETER

By LOUIS B. SKLAR



Fig. A. Exterior view of completed instrument.

WHILE methods of measuring resistances from a fraction of an ohm to several megohms are a greater convenience to the man in the radio or electrical laboratory, the ideal condition, however, has not as yet been reached; for the simple reason that in almost every case the readings are not direct for all resistance values within the range of the meters. In some cases, several curves have to be drawn or calculations and substitutions in mathematical formulas have to be used in order to arrive at the final results.

An ohmmeter having a range from 0 to 1 megohm, and possible 5 megohms, which will give all answers direct and accurate and without any calculations, has long been the goal of radio and electrical engineers.

With this view in mind the writer devised a new type of ohmmeter that overcomes these objections. There is really nothing radically new in the method used for measuring resistance values except that the different shunts used for the measurement of values from a fraction of an ohm to 1 megohm are so arranged that 1 curve, Fig. 3, is used for all readings. It is also seen from Fig. 3 that each value, whether it is 6 ohms or 600,000 ohms can be determined with the same percentage of accuracy. Anyone familiar with other type of ohmmeters will appreciate this feature.

Figure 1 shows the schematic layout of the ohmmeter and the parts required. The 0-to-1 ma. meter does not necessarily have to be part of the equipment. (The writer used a Weston 0-1. ma. meter which is part of a set analyzer.) All parts are assembled on a small box, as shown in Fig. A.

The D.C. source may be a "B" eliminator, three 45 V. "B" batteries, or anything which

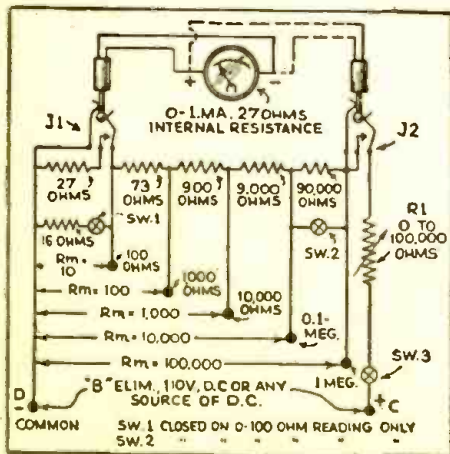

Fig. 1. Schematic circuit of ohmmeter and parts required. The constructor should study this diagram well and understand it before assembling the parts.

will give about 110 V. D.C. Since this D.C. does not have to be filtered, a receiving type tube rectifier can be used, as shown in Fig. 2, and as the equipment for this type of rectifier is very inexpensive it can be permanently incorporated in the circuit.

When all the wiring is completed, check it carefully; if everything is O.K., you may connect the D.C. source to the terminals marked D and C. You are now ready to plug the meter into jack J1. At any time, before the meter is plugged into the circuit, make sure that rheostat R1 is at maximum resistance. When the meter is in the circuit, adjust R1 until the meter shows full-scale

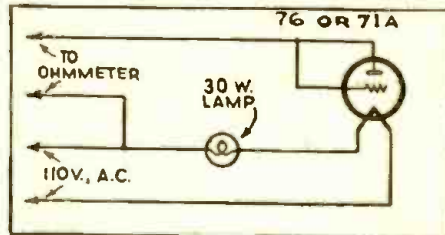

Fig. 2. The D.C. Supply for Fig. 1. Note that any tube connected as a diode rectifier may be used. The amount of current passing of course depends on the tube used.

deflection. The ohmmeter is now ready for operation.

To measure resistance values from 1/2-ohm to 100 ohms, close switches Sw. 1 and Sw. 2, and adjust R1 until the meter shows full-scale deflection. When the resistor to be tested is inserted between terminals D and 100 the meter will indicate a current flow of less than 1 ma.—let us say, .45-ma. From the curve, Fig. 3, we see that the corresponding resistance is 8 ohms. The reason for using the 16 ohm shunt resistor and S, will be explained later, under, "The Theory of the Circuit."

Measurements of resistance values ranging between 100 and 1,000, and between 1,000 and 10,000 are the same as explained for testing values between 1/2-ohm to 100 ohms, except that switches Sw. 1 and Sw. 2 remain open.

When resistance values higher than 10,000 ohms are to be tested, the procedure is as follows: first, place the unit of unknown resistance value between the correct terminals. Remove the meter from J1 and insert it in J2. Adjust R1 until the meter shows full-scale deflection. It will be observed that when the meter is inserted in J2, a resistance equal to the internal resistance of the meter is automatically replaced in J1. This provides greater accuracy in the final reading. Remove the meter from J2 and reinsert it in J1. The new reading on the meter is the one used for finding the unknown resistance value on the graph.

The purpose of placing the meter in J2

before the reading is taken, is to make sure that the total current in this circuit is not more than 1. ma. This procedure is very important when high-range resistors are being tested, as the current through the circuit is being appreciably affected by the different values of the resistors to be tested. In the lower ranges, up to 1,000 ohms, the change in current can be considered negligible for all practical purposes.

All parts used are of standard make and in most cases will be found in the junk heap. The odd-value resistors, such as 16 ohms, 27 ohms, etc., can be easily constructed by unwinding any old wire resistors, until there remains just the right value.

The graphs, Figs. 3 and 4, may be pasted on a piece of cardboard and hung up at a convenient place in the laboratory or workshop; or, they may be pasted on the resistance box.

## THE THEORY OF THE CIRCUIT

We know that when a resistor is placed across the terminals of an ammeter or milliammeter the current which was originally flowing in the meter is now divided between the internal resistance of the meter and the shunt resistance. Mathematically it is expressed as follows:

$$R_m = \frac{I_s}{I_m} \text{ where } R_m = \text{internal resistance of the meter. } I_s = \text{shunt resistance, } I_m = \text{current through the shunt, and } I_m = \text{current through the meter.}$$

When the full-scale deflection of the meter is 1. ma., as it is the case here, this

(Continued on page 158)

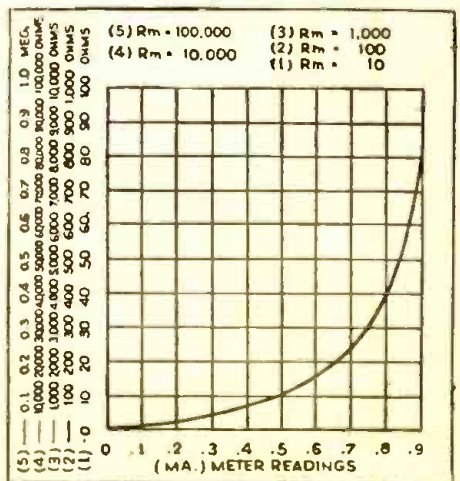

Fig. 3. Curve of meter readings. Note it is similar for all ranges, it being necessary only to observe the proper scale when making comparisons. A graph of this sort enables you to determine what to expect if any changes must be made.



# SEVEN NEW RADIO TUBES

RCA has announced seven new tubes. It is refreshing to note that scientific progress in the radio industry continues, despite the real demands made on it by the necessity of winning the war.

RADIO-CRAFT takes pleasure in presenting these tubes with their characteristics, at length. While these new tubes are available only with priority and therefore probably cannot be bought by the average serviceman and experimenter, we are certain that our readers will welcome the publication of these new tubes, just released. They show the new trend of the times. These tubes should be of more than passing interest, particularly the electronic types.

**T**HE tubes reviewed here of course may not be generally available until after the war. However, for the benefit of those who wish to keep abreast of modern developments the data are presented for reference.

### 2API TWO-INCH C-R TUBE

The high-vacuum cathode-ray 2API tube will be of interest to servicemen and radio technicians. Two inches in diameter, 7 7/16" in overall length, this C-R tube is similar to the type 902 except that it has separate leads to all deflecting electrodes and to cathode. It employs a magnal 11-pin base, and can be operated with higher anode voltages. Focusing and deflection are obtained by electrostatic means. Fluorescence is green with medium persistence. (For details see Table I.)

### 5R4-GY

This is a coated-filament type, full-wave, high-vacuum rectifier, having a maximum peak inverse-voltage rating of 2800-volts, a peak plate-current rating of 650 milliamperes, and a maximum d-c output current rating of 175 milliamperes when choke-input type filter is used. It has a micanoil base. (For details See Table II.)

### 935 PHOTOTUBE

The 935 is a high-vacuum phototube, possessing extraordinarily high sensitivity to radiant energy which is rich in blue and near-ultraviolet. It will respond in the region down to about 2000 Angstrom units. It employs a bulb of special glass, and a top cap to provide high resistance to leakage currents between electrodes.

Because of its excellent stability, consistency of spectral response, and extremely high sensitivity, the 935 is particularly suited for use in measuring ultraviolet absorption

of gases and liquids. In such applications, its lack of response to infra-red radiation may be an important advantage. (See Table III.)

### 934 PHOTOTUBE

This high-vacuum phototube, 2 1/2 inches high, is intended primarily for use in sound and facsimile equipment, but may also be used in light-operated relays and light-measuring equipment. Its S-4 photosurface has exceptionally high response to blue and blue-green radiation. Its response to red radiation is negligible. (See Table IV.)

### 1C21 COLD GAS TRIODE

Cold cathode (ionic-cathode) glow-discharge triode designed for use primarily as a relay tube. The discharge can be initiated with a very small amount of electrical energy applied to the grid circuit. The 1C21 may also be used as a voltage regulator, or as a relaxation oscillator.

The bulb is sprayed with an opaque coating so that incident light will not affect the breakdown characteristics. (See Table V.)

### 6AG5

Miniature type R.F. pentode, with a sharp cut-off characteristic, and a high value of transductance. It is useful in compact lightweight equipment, as an R. F. Amplifier (up to about 400 megacycles) and as an intermediate amplifier for high frequencies. It has low input capacitance and low output capacitance. (See Table VI.)

### 6J6 MINIATURE TRIODE

Two grids and two plates in one envelope, with a common cathode indirectly heated. The twin units may be operated in parallel or in push-pull. With push-pull arrangement of the grids, and with the plates in parallel, the 6J6 is particularly useful as a

mixer at frequencies as high as 600 megacycles. It is also useful as an oscillator. (See Table VII.)

TABLE I—2API  
Maximum Ratings

Heater Voltage (A.C. or D.C.)	6.3 volts
Heater Current	0.6 amps.
Anode No. 2 (High-Voltage Electrode) Voltage	1100 max. volts
Anode No. 1 (Focusing Electrode) Voltage	500 max. volts
Grid (Control Electrode) Voltage	Never positive
Peak Voltage Between Anode No. 2 and Any Deflecting Electrode	660 max. volts
D-C Heater-Cathode Potential	125 max. volts
Grid-Circuit Resistance	1.5 max. megohms
Impedance of Any Deflecting-Electrode Circuit at Heater-Supply Frequency	1.0 max. megohm
Typical Operation:	
Anode No. 2 Voltage*	500 1000 volts
Anode No. 1 Voltage for Focus at 75% of Grid Voltage for Cut-Off (Approx.)**	125 250 volts
Grid Voltage for Cut-Off*	-30 -60 volts
Deflection Sensitivity:	
DJ1 and DJ2	0.220 0.110 mm/volt d.c.
DJ3 and DJ4	0.260 0.130 mm/volt d.c.
Deflection Factor (20% variation)	
DJ1 and DJ2	115 230 volts d.c./in.
DJ3 and DJ4	98 196 volts d.c./in.

TABLE II—5R4-GY  
Maximum Ratings

Filament Voltage (A.C.)	5 volts
Filament Current	2 amps.
Peak Inverse Voltage (No-Load Conditions)	2800 max volts
Peak Plate Current per Plate With Condenser-Input Filter:	650 max. milliamps.
A-C Plate Voltage per Plate (RMS)	
Full Load	700 900 volts
No Load	750 1000 volts
Total Effective Plate-Supply Impedance per Plate	125 575 ohms
D-C Output Current	250 max. 150 max. milliamps.
With Choke-Input Filter:	
A-C Plate Voltage per Plate (RMS)	
Full Load	750 950 volts
No Load	850 1000 volts



Input-Choke Inductance 5 min. 10 min. henries  
D-C Output  
Current 250 max. 175 max. milliamperes

TABLE III—935 PHOTOTUBE

Tentative Characteristics and Ratings

Cathode	Semi-cylindrical	
Cathode Photosurface	S4	
Cathode Window Area	0.9 sq. in.	
Direct Interelectrode Capacitance	0.6 µf	
Overall Length	4" to 4 1/4"	
Seated Height	3-7/16" to 3-11/16"	
Maximum Diameter	1-5/16"	
Bulb	T-9	
Cap	Skirted Miniature	
Base	Intermediate Shell Octal 5-Pin	
Mounting Position	Any	

Maximum Ratings

Maximum Ratings Are Absolute Values

Anode-Supply Voltage (D.C. or Peak A.C.)	250 max.	volts
Anode Current*	20 max.	microamp.
Ambient Temperature	50 max.	°C
Sensitivity**	30	microamp./lumen

Sensitivity at 2537

Angstroms	0.02 approx.	microamp./microwatt
-----------	--------------	---------------------

D-C Resistance of Load:  
For 250-volt anode-supply voltage

1 min.	megohm
--------	--------

\*On basis of the use of a sensitive cathode area 1/8" in diameter.

\*\*Sensitivity value is given for conditions where a Mazda Projection Lamp operated at a filament color temperature of 2870°K is used as a light source. The method for determining sensitivity employed a 250-volt anode supply and included a 1.0-megohm load resistance. With daylight, value is several times higher; to light from a high-pressure mercury arc, many times higher.

INSTALLATION

The base of the 935 fits a standard octal socket which should be mounted so that the light is intercepted by the concave surface of the cathode.

Exposure to intense light, such as direct sunlight, may decrease the tube's sensitivity even though there is no voltage applied. The magnitude and duration of the decrease depend on the length of the exposure. Permanent damage to the tube may result if it is exposed to radiant energy so intense as to cause excessive heating of the cathode.

Shielding of the 935 and its leads to the amplifier is recommended when amplification is high. The leads from the phototube to the amplifier should always be as short as possible to minimize capacitance loss and pick-up from stray fields. Since the tube is a high-resistance device, it is important that insulation of associated circuit parts and wiring be adequate.

When maximum sensitivity of phototube circuits is important, special care should be taken to keep the leakage resistance of circuit parts and wiring insulation high. Leak-

age across moisture films on the surface of the glass can be prevented by coating the glass with pure white ceresin wax, or other non-hygroscopic wax. It is not necessary to coat the whole bulb. A continuous band of wax, approximately a half-inch wide, around the top-cap or around the bulb is sufficient to interrupt all external leakage paths across the phototube surface. Under these conditions, a minimum leakage resistance of 500,000 megohms may be expected.

TABLE IV—934 PHOTOTUBE

Tentative Characteristics and Ratings

Cathode	Semi-cylindrical	
Cathode Photosurface	S4	
Cathode Window Area	0.4 sq. in.	
Direct Interelectrode Capacitance	1.5 µf	
Maximum Overall Length	2-15/32"	
Maximum Seated Height	2"	
Maximum Diameter	23/32"	
Bulb	T-5 1/2	
Base	Peewee 3-Pin	
Mounting Position	Any	

Maximum Ratings

Maximum Ratings Are Absolute Values

Anode-Supply Voltage (D.C. or Peak A.C.)	250 max.	volts
Anode Current*	10 max.	microamp.
Ambient Temperature	50 max.	°C
Sensitivity**	30	microamp./lumen

D-C Resistance of Load:  
For 250-volt anode-supply voltage

1 min.	megohm
--------	--------

\*On basis of the use of a rectangular sensitive cathode area 17 mm by 7.5 mm.

\*\*Sensitivity value is given for conditions where a Mazda Projection Lamp operated at a filament color temperature of 2870°K is used as a light source. The method of determining sensitivity employed a 250-volt supply and included a 1.0-megohm load resistance. With daylight, value is several times higher; to light from a high-pressure mercury arc, many times higher.

INSTALLATION

The socket of the 934 should be mounted so that light is intercepted by the concave surface of the cathode.

Exposure to intense light, such as direct sunlight, may decrease the tube's sensitivity even though there is no voltage applied. The magnitude and duration of the decrease depend on the length of exposure. Permanent damage to the tube may result if it is exposed to radiant energy so intense as to cause excessive heating of the cathode.

Shielding of the 934 and its leads to the amplifier is recommended when amplification is high. The leads from the phototube to the amplifier should always be as short as possible to minimize capacitance loss and pick-up from stray fields. Since the tube is a high-resistance device, it is important that

insulation of associated circuit parts and wiring be adequate.

When maximum sensitivity of phototube circuits is important, special care should be taken to keep the leakage resistance of circuit parts and wiring insulation high.

TABLE V—1C21 COLD GAS-TRIODE  
Tentative Characteristics and Ratings

Maximum Overall Length	2 5/8"	
Maximum Seated Height	2-1/16"	
Maximum Diameter	1-5/16"	
Bulb	T-9	
Base	Intermediate Shell Octal 6-Pin	
Mounting Position	Any	

Characteristics

Peak Anode Breakdown Voltage (Grid tied to cathode)	180 min.	volts
Peak Positive Grid Breakdown Voltage	66 min.	volts
	80 max.	volts
D-C Anode Extinction Voltage	73 approx.	volts
Grid Current (For transition of distance to anode at 100 volts peak)	25 av.	microamp.
	50 max.	microamp.
Anode Voltage-Drop	73 approx.	volts
Grid Voltage-Drop	55 approx.	volts

Maximum Ratings

Maximum Ratings Are Design-Center Values		
Peak Cathode Current	100 max.	milliamp.
D-C Cathode Current	25 max.	milliamp.
Typical Operation as Relay Tube:		
D-C Anode Supply Voltage	125-145	volts
Peak Positive Grid-Bias Voltage	66 max.	volts
Peak Grid-Signal Voltage	40 min.	volts
Sum of Grid-Bias and Grid-Signal Voltages (Peak)	100 min.	volts
D-C Grid Current	100	microamp.

INSTALLATION AND APPLICATION

The base of the 1C21 fits the standard octal socket which may be installed to hold the tube in any position.

When the 1C21 is used in relay service, provision should be made to supply to the grid a signal voltage adequate to take care of voltage supply regulation, tube variation, and manufacturing variation in the equipment itself.

The typical operating data shown in the tabulation are for the 1C21 when used as a relay tube with a D.C. voltage supply which may vary from 125 to 145 volts. The corresponding values of bias voltage and grid-signal voltage have been chosen to take care of this voltage range as well as other variations. The required amount of peak grid-signal voltage can be reduced substantially either by reducing the supply-voltage range, or by adjusting the equipment to take care of differences between (Continued on page 163)

KEY TO TERMINAL DESIGNATIONS OF SOCKETS

Alphabetical subscripts D, P, T, and HX indicate, respectively, diode unit, pentode unit, triode unit, and hexode unit in multi-unit types.

Numerical subscripts are used (1) in multi-grid types to indicate relative position of grids to cathode or filament, and (2) in multi-unit types to differentiate between two identical electrodes which would otherwise have the same designation.

- BP = Bayonet Pin
- BS = Base Shell
- F = Filament
- FM = Filament Mid-Tap
- G = Grid
- H = Heater
- HL = Tap for Panel Lamp
- K = Cathode
- NC = No Connection

- P = Plate (Anode)
- PBF = Beam-Forming Plates
- RC = Ray-Control Electrode
- S = Shell
- SI = Interlead Shield
- SL = Base Sleeve
- TA = Target
- U = Unit
- \* = Gas-Type Tube

Bottom views of sockets are shown throughout.

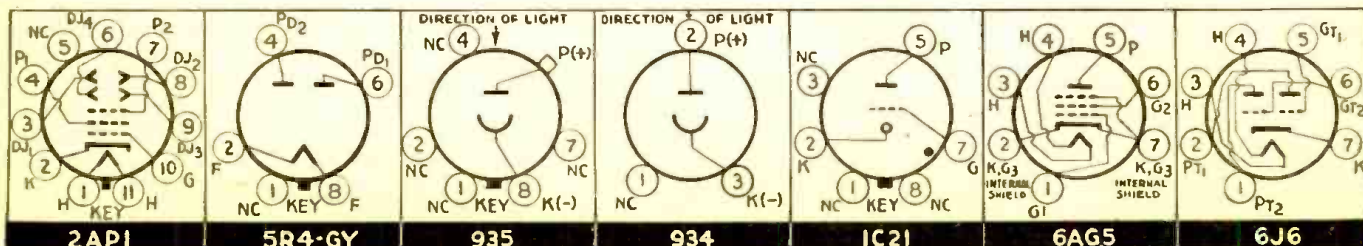

# ELECTRICAL QUANTITIES

By WILLARD MOODY\*

Most of our readers are already familiar with the helpful and instructive explanations of electrical theory which Mr. Moody has given us from time to time. In these days when thousands of school boys and young men are studying radio before entering the armed forces, they must cram in a month or two what usually takes a year to learn. So to these young men we say that Mr. Moody's articles will be found of tremendous interest and assistance.

**T**HE volt is the unit of electromotive force or potential difference, which will send a current of 1 ampere through a resistance of 1 ohm. A standard battery in the Bureau of Standards has a terminal voltage or potential difference of 1 volt, when constructed according to certain specifications. In radio work, sensitivity of a receiver may be stated in micro-

A milliamper is an ampere divided by 1,000, or expressed decimally is 0.001 ampere. An ampere is the current that flows in a circuit having a resistance of 1 ohm and a voltage or potential difference of 1 volt.

In certain instruments, the sensitivity or full scale reading may be 50 micro-amperes. A micro-ampere is an ampere divided by 1,000,000.

Current may be thought of as a flow of electrons through a wire similar to a flow of water in a pipe. A heavy current (or large number of amperes) is like a flow of several gallons of water per second. A light current would have a small number of amperes. In radio, a small current would be measured in micro-amperes. An ordinary house fuse has a rating of ten or fifteen amperes in the branch circuit, and may be 25 amperes in the wattmeter circuit. A radio of average console size might draw 1½ amperes from the 115 volt power line. A 150 watt bulb would draw about the same current in amperes on the same line.

### RESISTANCE

Resistance is stated in ohms. An ohm is the unit of opposition offered to the flow of electric current, and in the Bureau of Standards is the resistance of a piece of special wire under certain conditions of temperature. One ohm will be equal to 1 volt divided by 1 ampere. That is Ohm's Law and was discovered by a scientist named Simon Ohm in whose honor the unit is named. Ohm's Law is so fundamental and is used so often in radio and electrical work that it must be thoroughly understood.

Ohm's Law states that current flowing in a circuit is equal to the voltage across the circuit, divided by the resistance of the circuit, or expressed in symbols:

$$I = \frac{E}{R}$$

This relation holds true only when I is in amperes, E is in volts, and R is in ohms. If a current was measured in milliamperes (or thousandths of an ampere), it would have to be changed to amperes by being expressed as a decimal part of an ampere, before being used in the Ohm's Law formula.

Suppose R were in megohms (mega, million, plus ohms). It would not have to be changed to be used in the formula, because it is already in ohms.

### POWER

The electrical power in a circuit is rated in watts. One horsepower is equivalent to 746 watts. In amateur radio transmitters the plate power to the final stage is legally limited to 1,000 watts or 1 kilowatt. A large broadcasting station, on the other hand, may have a power of 50,000 watts or 50 kw.

An ordinary console radio may have a power rating of 150 watts; but the circuit resistors used in that radio are rated 1

watt or ½ watt. An electric soldering iron might have a rating of 100 watts, and an electric clock might draw no more than ½ watt.

The watt in a direct current circuit is equal to the product of voltage and current, or expressed as a formula:  $W = I E$ .

The watt is the unit of electrical energy or work, hence the symbol "W." Lately,

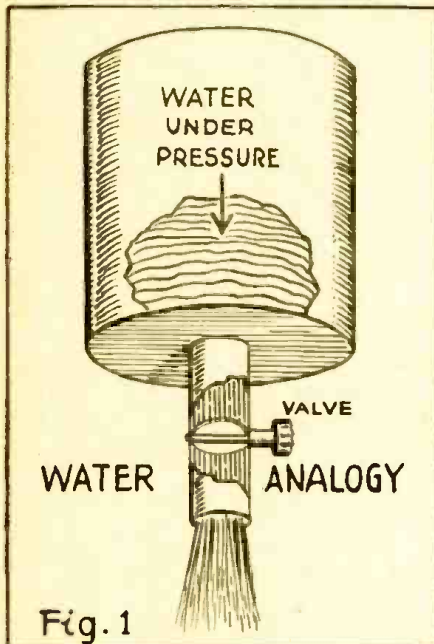

volts. A microvolt is a volt divided by the number 1,000,000, or 10 raised to the minus six power. Sensitivity is also stated, occasionally, in millivolts per meter. A millivolt is a volt divided by 1,000.

Voltage may conveniently be considered as pressure. The idea of a water tower filled with water and exerting pressure upon the surface of a pipe connecting to the tower is a simple analogy or explanation, Fig. 1.

A storage battery or dry cell may be considered a reservoir of electrical energy from which current is drawn when the pipe connecting to the battery is not plugged up. If a plug in the form of resistance is inserted in the pipe, there will be opposition to the flow of current and only a thin stream will leak through. Electrical leakage is very similar. The positive terminal of the battery of electrical generator may be thought of as the point where the pipe connects to the tank and the pressure exerted on the pipe at this point will be the potential force or voltage.

### CURRENT

The current in an electric circuit is rated in amperes or fractional parts of the ampere. In radio work a meter may have a movement, or full scale reading of 1 milliamper.

\*Radio Instructor

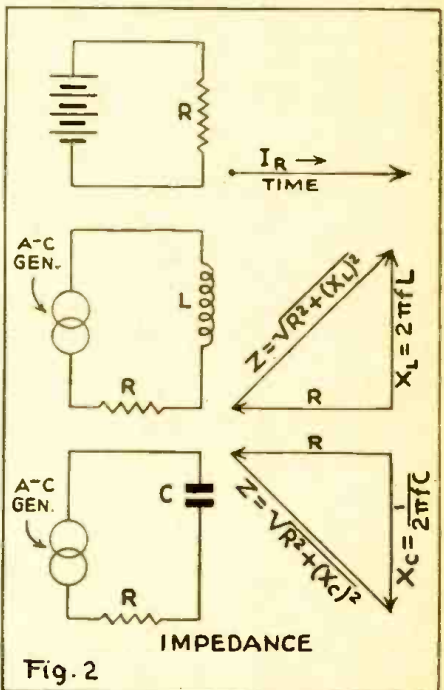

however, the symbol "P" has enjoyed wide usage and also represents wattage or power. The capacity of a water tank represents the electrical power in a water analogy. The wattage dissipation of a resistance will be the power lost as the result of heating the resistance, which is work done. An electric lamp, when heated, radiates both heat and light. That is, the conversion of electrical power into other useful form of energy. A radio loudspeaker will convert electrical power into mechanical power, and this in turn will set up a pressure in the air which reacts on our ear drums. The pressure on the ear drum is then converted into an electrical current in the nerve and transmitted to the brain, where we receive consciousness of the sound heard.

An electric motor, when fed electrical power, turns its shaft and does work. Conversely, an automobile generator has its shaft turned by engine, and is thus supplied mechanical power, which it converts or changes into electrical power that is used to charge up the storage battery in the car's ignition system.

### POWER FACTOR

The power is an alternating current cir-

circuit will be equal to the product of three factors, that is, voltage, current, and a third factor called the "power factor."

The power factor of a circuit is the percentage of resistance in the circuit. A lamp bulb, being all resistance practically, has unity power factor; this is expressed as 1. The voltage times the current times 1 will be the power. If the power factor is something less than 1, it will be expressed as a percentage, say 90%, which is shown as .9 and is used to multiply the voltage and current.

An ordinary A.C. voltmeter or ammeter, such as used in radio servicing or electrical power work, will read in what are termed effective values. The effective value of an alternating current produces the same heat in a one-ohm resistance, as the heat that is produced by a direct current. If the direct current voltage were 1 volt and the resistance were 1 ohm, the current would be 1 ampere. If an effective alternating current voltage were supplied to a resistance of 1 ohm, the effective current would be 1 ampere and the heat produced in the 1 ohm resistance would be the same as with the direct current. The power would also be the same and the power factor would be 1, or unity.

The power factor in an alternating current circuit takes into account a quantity called impedance. The symbol "Z" is used to represent impedance and this quantity is stated in ohms. The ratio of R to Z is called the power factor. That is, R divided by Z equals the power factor. In a parallel circuit of inductance and capacity, at resonance, the impedance is minimum and is a pure resistance. This is so because the reactances of the circuit have cancelled out and only the resistance of the coil is left. All these new terms will be explained fully as we go on, Fig. 3.

The power factor is also equal to the cosine of the phase angle, or,  $\cos \theta$  (theta) equals R divided by Z.

PHASE ANGLE AND REACTANCE

In a direct-current circuit, when the battery is connected to a resistance, the current immediately climbs to its peak or maximum value and remains there so long as the battery is connected. The action is instantaneous or occurs at once, Fig. 5.

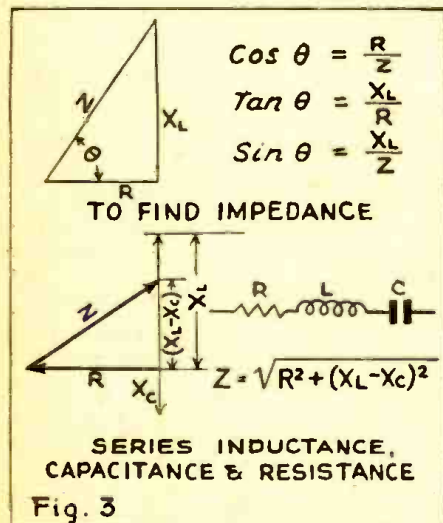

In an alternating-current circuit, when voltage is applied to a coil, the current does not immediately flow into the coil because there is a magnetic field about the turns of wire in that coil, which creates a back electromotive-force that is opposite in direction to the applied electromotive force or voltage. As a result, there is a time-lag between current and voltage, and the volt-

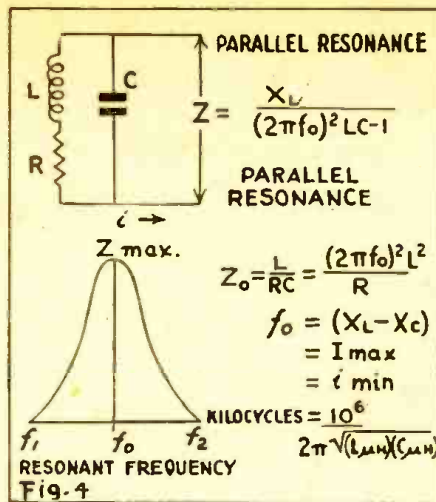

age in a coil circuit leads the current by 90 degrees. This effect is called reactance and is measured in ohms, just as impedance and resistance are measured in ohms. The inductive reactance limits the current flow in an alternating current circuit. The current I will be equal to E divided by X. The symbol for reactance is X, Fig. 2.

It is obvious that the effect of the inductance of the coil, is to limit the current. This limiting will increase as the frequency of the alternating current is increased. The equation for inductive resistance is:

$$X_L = 2\pi fL$$

where "L" is the inductance in henrys, "f" is frequency in cycles and "X<sub>L</sub>" is the inductive reactance in ohms.

CAPACITANCE AND REACTANCE

As the reactance of the coil increases with frequency or an increase in the inductance, the reactance is said to be a positive quantity.

A condenser or capacitor, on the other hand, has a negative characteristic. Its reactance varies inversely or negatively as the capacity or frequency is raised. The equation for capacity reactance is:

$$X_C = \frac{1}{2\pi fC}$$

where "X<sub>C</sub>" is in ohms, "C" in farads, "f" in cycles.

When voltage is applied to a condenser, current flows into the plates of the condenser. But before there can be a potential difference between the condenser plates, or before those plates can acquire or get a charge of electricity, current must flow into the plates. Thus, the current gets there first and the current is said to lead the voltage by 90 electrical degrees. The voltage is said to lag the current (which is just the opposite of what holds true in the case of the coil).

In a direct current circuit voltage and current reach their peaks (or maximum values) at the same instant.

In an alternating-current circuit the voltage and current reach their peak values at the same instant only when the circuit is composed of pure resistance and has no reactance. Under that condition the power factor, or ratio R/Z, is said to be unity, and the circuit is termed "resistive." If the power factor is less than 1, the circuit is partially "reactive."

An example of such a condition occurs in parallel resonant circuits (that is, tuning circuits), where, when the condenser (or the inductance in some cases) is tuned, the reactance of the condenser equals the reactance of the inductance. Being equal there is no effect on the phase relationship, so

the resistance limiting current flow consists of the resistance of the wire in the inductance and in the leads. This resistance has no effect on the phase angle. The so-called peak of the resonant frequency is attained under these conditions. (See Fig. 4.)

The diagram shown, consisting of L, R and C is the equivalent circuit of the inductance, with its d.c.-resistance R; and the condenser C. L and C of course are in terms of ohms to make this equivalent circuit uniform.

The formulae given show the relationships existing; and the resonant frequency diagram shows peak or resonant frequency between two side-band frequencies f-1, and f-2.

SUMMARY

It is important to remember that power is never lost in a pure reactance. Power is lost only in resistance. Reactance stores energy, and it is the reactance of a coil or condenser that makes the coil or condenser act as an electrical storage tank. In a parallel circuit, at resonance, when coil reactance equals condenser reactance, there is a cycle of energy being poured from coil to condenser and vice versa. It's like having two glasses, one filled with water and the other empty. You take the water in one glass and pour it into the other, then back again. You can repeat this indefinitely. If you spill some of the water, that is power lost. Your clumsiness represents resistance. If you are very clumsy, you are very resistive and lose power readily. A coil having a high resistance would lose power constantly in the circuit, until all of the available power was used up. The same applies to a condenser. In any case, the more effi-

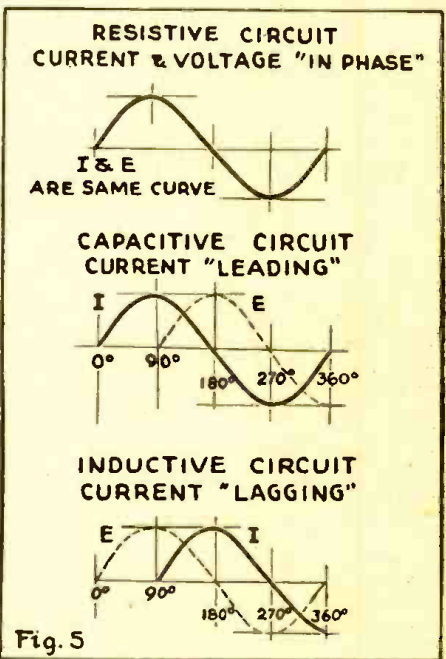

cient is the coil or condenser, the less is the power factor. The energy being poured back and forth represents reactive or circulating current. It is phantom or unreal power although the current is there and is very real. The wires or conductors in an alternating current system, such as the wiring in a factory, must carry reactive current if the power factor of the line is not close to 100%. Synchronous motors are sometimes switched into such circuits, because they draw a reactive current which balances the system and restores the power factor.

# HOMODYNE RECEPTION

*Possibilities of the System as an Aid to Selectivity*

THE "homodyne" system of reception is a little-known member of the family of radio "dynes," so let us first see how it is related to its cousins heterodyne, super (sonic)-heterodyne and autodyne. The word "dyne" is derived from the Greek for power, so that *heterodyne* merely means putting in energy at a *different* frequency, and becomes "supersonic-heterodyne" if the frequency difference is greater than audible (e.g. 465 kc/s), while *autodyne* means putting in its *own* power, i.e. a self-oscillating detector. Similarly, *homodyne* means that energy is put in at the *same* frequency, i.e. in synchronism with the carrier of the signal which it is desired to receive, and this is the system which may be able to help us with the selectivity problem.

## INTERFERENCE

Interference can be divided into two categories, the type which involves the carrier of the wanted signal, and the type which does not. In the first category we have the direct heterodyne between the wanted carrier and a neighboring carrier, "side-band splash" which consists of heterodynes between the wanted carrier and the side-bands of the interfering signal, and cross-modulation; in all of these the output of interference is merely proportional to the weaker of the two frequencies which are beating together so that increasing the strength of the wanted carrier makes no difference to the interference. Before we can benefit from the homodyne principle, therefore, adjacent carriers must be spaced far enough apart for the heterodyne note to be outside the audio-frequency band, or alternatively the heterodyne must be eliminated by means of a "whistle filter" of some sort. The latter alternative is not the ideal solution, since it involves eliminating the same frequency (or rather a band of frequencies) from the program; but if the filter has a narrow enough attenuation band, it may be a tolerable method. It seems likely to take a very long time to produce sufficient public demand for high-fidelity broadcasting on the medium-wave band to secure the sacrifice of a number of stations to adequate spacing of channels; in fact, it is a debatable point whether the introduction of wide-band U-H-F broadcasting would render superfluous high fidelity on the medium-wave transmissions, or whether the experience of really good quality would lead to a demand for it on all transmissions. Assuming, however, that we have by some means eliminated the adjacent-channel heterodyne, and taken the necessary precautions against cross-modulation (which means practically building a receiver with RF stages that never overload), the residual interference will consist of the whole modulated signal (carrier plus side-bands) of a transmitter on a neighboring frequency.

## SELECTIVITY LIMITATIONS

There is an essential distinction between the wanted and unwanted signals, by reason of the fact that they have different carrier frequencies, and so it may be possible to eliminate the interference which consists solely of the independent signal more effectively than heterodynes, etc., which involve the carrier of the desired signal. But first one must answer the natural question, why not rely on selective circuits? Now, reason-

able program enjoyment requires a signal/interference ratio of 40 db., and for high-fidelity reception the ratio should be 60 db., i.e. a voltage ratio of 1000:1; add to this the condition that ideally one should be able to receive the weaker of two adjacent stations, say with a field-strength ratio of 10:1, and if the reader then thinks it is easy to design a receiver with adjacent-channel selectivity of 10,000:1, he need not worry about homodyne receivers.

## LINEAR DETECTORS

The phenomena underlying homodyne reception actually occur to some extent in every receiver using a linear rectifier; (that is to say almost every modern receiver that has a reasonably strong signal tuned-in); one of the phenomena is that a linear rectifier is most sensitive to signals that are in the same phase as the strongest signal out of several applied to it. In the ordinary diode rectifier, the diode is automatically biased by the signal so that it is only conducting for a small part of the cycle, say the extreme positive values of the voltage wave, as shown in Fig. 1. If now the ampli-

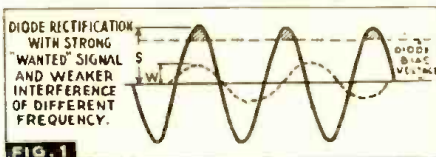

FIG. 1 Interference and effect of bias in diode detection. The diode conducts during the parts of the cycle are shown shaded.

tude of the signal is varied by modulation, there will be a change in the height of the voltage peaks, therefore an increase or decrease of diode conduction, and this in turn will change the bias voltage so that conduction occupies the same *proportion* of the whole cycle as it did for the original amplitude. But the bias voltage on the diode is in fact the rectified output, so that variation of this voltage with the input represents an output signal proportional to the amplitude modulation of the input signal.

## DETECTOR DISCRIMINATION

Now suppose there is added to the input a smaller signal, at a different frequency, as suggested by the dotted curve in Fig. 1. The first positive peak of this second signal falls

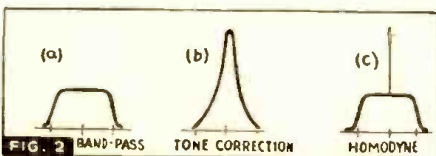

FIG. 2 Homodyne reception compared with other methods of obtaining selectivity. Note the similarity of homodyne reception to the bandpass curve.

fairly well on the conduction period (determined mainly by the strong signal) and therefore increases the rectified current; but the second positive peak falls in a non-conducting period and therefore cannot affect the output, while the second conduction

period is accompanied by a *negative* peak of the smaller signal, which reduces the rectified output and so tends to oppose the effect produced in the first conduction period. It is obvious that the weaker signal has relatively little effect if of different frequency from the stronger one, since it is the latter which decides when the diode is conducting: as often as not the weaker signal comes up positive when the diode is thoroughly cut off by the stronger signal, and on those occasions when the diode is conducting, the weaker signal is as likely to be negative as positive. This is only a very rough picture of the action, because the frequency-difference is greatly exaggerated in Fig. 1, and no allowance is made for changes in duration of the conduction periods when the weak signal reaches a maximum or minimum near the edge of a conduction period; when it has been properly worked out mathematically, the ratio of the AF outputs due to modulation on the strong signal S and on the weak signal W is approximately  $2S^2/W^2$ , and the phenomenon is known as "the apparent demodulation of a weak signal by a strong one" (or, more briefly, "rectifier discrimination"). To see how useful this is, suppose that by means of selective circuits we have made the wanted station supply a carrier voltage 10 times greater than that of the unwanted station at the input to the detector: this represents a signal/interference ratio of 20 db., which would not be very good. But if  $S/W = 10$ , the ratio of the audio-frequency output voltages is  $2S^2/W^2 = 200$ , or 46 db., which is tolerably satisfactory.

## SELECTIVITY AND TONE CORRECTION

In early receivers this gain from linear detection was not always obtained, because the signal level at the detector was so small that the detector did not function as an on/off device, as described in connection with Fig. 1, but as an approximately square-law device which conducted rather better in one direction than the other; since the stronger signal was thus not sufficient to stop conduction for part of the cycle, the weaker signal could always produce some effect, regardless of its phase relation to the stronger signal, and no rectifier discrimination was obtained. One of the first specialized systems to obtain this advantage (though the mechanism was not at first understood) was the "tone-correction" type of receiver. The RF circuits (including the IF, if any) were made of maximum Q, so that a very high gain was obtained at carrier frequency and low modulation frequencies, though the higher sidebands were relatively cut by a very large amount, and after detection the severe top cut was corrected by AF tone-correction circuits.

## RECTIFIER DISCRIMINATION

Owing to the strong carrier, this gave good "rectifier discrimination," but the top boost in the AF circuits exaggerated any harmonics produced in the process of rectification or by asymmetry of the RF circuits: 2 per cent to 5 per cent of harmonics in the output of the detector could become something like 50 per cent harmonics in the loudspeaker, and the popularity of this system was short-lived. In fact, it died a natural death with the development of the super-heterodyne and AVC; the latter required a

large enough amplitude at the detector to insure linear rectification, while the former provided the means of getting sufficient gain, and at the same time made it technically feasible to use selective band-pass circuits with a square-topped response, giving good adjacent-channel selectivity without requiring tone-correction.

But good tuned circuits are expensive and critical in adjustment, even when they work at a fixed intermediate frequency, and of recent years the number of high-powered transmitters has been greatly increased, so that once again selectivity is a problem. The tone-correction system was on the right track, but the top boost in the AF circuits was an intolerable nuisance; the solution then appears to be to increase the amplification of the carrier only, while retaining a uniform amplification for all the sidebands from lowest to highest, and this is the homodyne system. The three systems are represented diagrammatically in Fig. 2: diagram (a), normal receiver with square-topped response curve; (b), sharp circuits requiring subsequent tone-correction; and (c), homodyne receiver with carrier only accentuated. If wanted and unwanted signal reach the detector with equal amplitudes, the result will be a hopeless jam; but if we can add to the desired signal an artificial carrier of just over 30 times the existing carrier strength of either, we immediately obtain a rectifier discrimination  $2S^2/W^2$  equivalent to  $66\text{dB}$ , and reception is perfect, without any disturbance of the audio-frequency response characteristic. In fact, the audio-frequency performance is improved, because an incidental advantage of the homodyne system is the elimination of one source of distortion in the detector. With a normal diode detector feeding a load circuit whose AC impedance is less than its DC resistance, distortion occurs when the depth of modulation exceeds some value such as 75 per cent (depending upon the ratio of AC to DC load); but when the carrier has been artificially increased for homodyne reception, the depth of modulation will always be small, so that the ratio of AC to DC detector loads is no longer critical.

**ARTIFICIAL CARRIER**

The problem, of course, is how to produce this artificial carrier, which must be exactly in phase with the original carrier of the wanted signal, and there are two main lines of attack. According to one method, the carrier is selected from the input by some form of filter, and amplified more than the sidebands. There are various methods of inserting the filter in the circuit, and a method of selective negative feedback has been suggested as suitable (Patent No. 533784, abstract published in *Wireless World*, Jan., 1942); but this does not go far towards solving the problem, for the filter still has to have a very narrow response, even if it is connected in the negative-feedback line instead of in a straight-forward coupling between two stages of amplification. It can be assumed that the receiver is a superhet., and probably the IF will be 465 k.c. while the lowest audio-frequency can be put at 50 cycles per second. (Any rise in the response to frequencies below 50 cycles per second can be easily offset by a falling-off in the characteristics of loudspeaker and AF amplifier.) The carrier-selecting filter must therefore have a band-width of not more than  $\pm 50$  cycles per second in 465 k.c./s which is a fairly difficult proposition even for a crystal filter. In addition, the intermediate frequency must then be correct to something like 20 cycles per second, which means that both the accuracy of tuning and the stability of the

local oscillator must be as good as 20 parts in a million for the higher-frequency end of the medium-wave band, and proportionately better for short-wave working.

The other line of attack is to use a local oscillator, somewhat similar to the IF beat oscillator used for CW reception, to generate the extra carrier voltage, and synchronize this oscillator with the signal carrier. Probably most experimenters have done this at some time or another with a receiver using a reacting detector: if the reaction control is smooth enough, reception free from beat note can be obtained although the set is gently oscillating. But this is not really a fair example of homodyne reception, since it involves also a great increase of Q of the tuned circuit, and hence loss of high audio frequencies, which would not be present with a separate oscillator. In any case, this is hardly a method of reception to let loose on the general public. But granted the use of a superhet circuit and a separate oscillator tube for generating the carrier, which is then a practically constant frequency, there are possibilities in the way of designing the oscillator specially so as to hold synchronism over as wide a range of frequency as possible, though even so, tuning would need to be exceptionally accurate, and oscillator drift small. One of the troubles is that on 100 per cent modulation the carrier of the signal to be received falls to zero, and the homodyne oscillator would then be almost certain to drop out of synchronism. (Some data on the effect of modulation on the synchronization of an oscillator were published by Eccles and Byard in an article in *Wireless Engineer*, Jan., 1941, Vol. 18, p. 2.) Another snag is that the artificial carrier from the local oscillator would predominate in the output from the detector, so the DC component could not be used for AVC, which would have to be derived from an independent IF circuit free from carrier injection.

**POSSIBILITIES OF DEVELOPMENT**

It is clear that a good deal of development would have to be done before a commercial broadcast receiver could be built on the homodyne principle. (Perhaps the problem might appeal to some of the amateurs whose transmitters are close down "for the duration.") But the whole history of radio is the development of tricky laboratory apparatus into something approaching a foolproof piece of household equipment. For example, think back to the days of the earliest receivers and compare them with the present-day superheterodyne. Instead of single-knob tuning and a dial engraved in k.c., meters, and station names, one used to have two dials, marked only in degrees, which had to be simultaneously at the correct setting before any but the local station could be received. Instead of AVC to keep a constant output level, there used to be a reaction control which usually needed progressive adjustment as one tuned round the waveband, in order to keep a high level of sensitivity. Instead of independent volume and tone controls, there would probably be a reaction control supplemented by a rheostat in the filament of the RF tube to control gain, and the expert would balance reaction and gain adjustments to secure the desired volume and band-width. Looking at this transformation of the radio receiver, and the parallel transformation of the television receiver from a 30-hole scanning disc in front of a neon lamp into the cathode-ray type of receiver, it does not seem unduly optimistic to say that the difficulties inherent in the homodyne system of reception could be overcome in a commercial design. —*Wireless World (London)*.



**4 STANDARD TYPES**  
of Amperite Regulators replace over 400 types of AC-DC Ballast Tubes now in use.  
Amperites are real REGULATORS... have patented Automatic Starting Resistor which prevents initial surge and saves pilot light... Ask Your Jobber.

**AMPERITE**  
THE *Simplest* WAY TO REPLACE **BALLASTS**  
WRITE FOR REPLACEMENT CHART  
**AMPERITE CO.** 561 BROADWAY, NEW YORK, N. Y.

**BIG BOY**  
MODEL 860

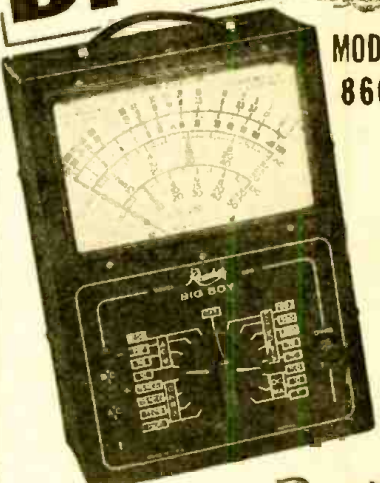

Performance... Eye Appeal... Value... Sensationally Priced at \$19.65. Dealer Net Price.

Here is an AC-DC Volt-Ohm-Milliammeter with all the ranges you want... easily readable on the large 7" instrument with extra-long 6" scale. In a new up-to-the-minute three-tone case. DC Volts 0-10-50-250-500-1000 at 5000 Ohms per volt DC; 1050 ohms per volt AC. AC Volts 0-10-50-250-1000 at 400 ohms per volt; DC Ma. 0-1-10-100; Resistance ranges: 0-1500 Low Chms; 0-150,000 Ohms and 0-7.5 and 0-15 Megohms. Carbon case with red and silver panel, attached handle.

Dealer Net Price. \$19.65  
For Catalog Write—Section 1117, College Drive  
**READRITE METER WORKS, Bluffton, Ohio**

# SQUARE WAVE MEASUREMENTS AND THEIR FUTURE

By WARREN MILLER

**T**HE first article on pulse generators, square-wave generators covered fundamental problems pertaining to design and service. The service angle discussed, covered the actual circuits involved, and showed results obtained on an oscilloscope, with equipment specially designed for the purpose. It is therefore imperative that recommendations and suggestions now be given so that the experimenter and research worker can duplicate the results.

## METHODS OF MEASUREMENT

Primarily we will concern ourselves only with the oscilloscope. The scope is the

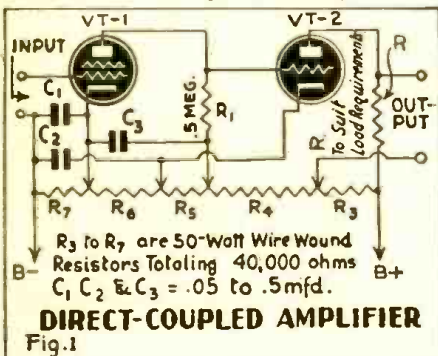

Direct-coupled amplifier to build up signal before applying to deflector plates of cathode-ray tube.

easy medium, at present, that will meet our requirements, because on the scope the actual results can be seen, and measured; and if done carefully, will be quite accurate. Measurements can be made in two ways:

- (1) Feed the signal direct to the deflecting plates of the scope tube.
- (2) Use an amplifier, usually incorporated in the scope.

## DIRECT FED SIGNALS

In the case where a signal can be fed directly to the deflecting plates two factors involved are the stray and input capacities of the circuit. However these capacitances come into question only when high-frequency measurements are made. At audio or supersonic frequencies they may be disregarded. The chief object to bear in mind is that the signal voltage be large enough to give sufficient deflection. Such voltage is usually 25 to 75 volts. Depending on the

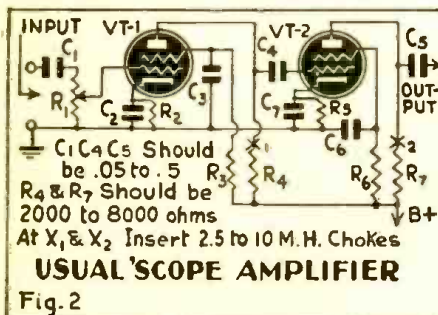

Some changes that could be made are indicated.

circuit under test, this voltage may, or may not, be available. If sufficient voltage is available, then all measurements can

*Experimenters, servicemen and advanced radio students will be very much interested in square waves; a subject which is becoming more and more important. Their accurate measurement calls for high-quality equipment, and how to use what you have is suggested by the author.*

easily be made, and accurate results obtained. Also, it might be suggested that, depending on the frequency worked, a high frequency transformer be used for "step-up."

## AMPLIFIED SIGNALS

When the signal voltage is low, an amplifier must be used. The amplifier should be the best obtainable, that is, its characteristics must be of the wide band variety, and it must be uniform in response throughout its band. Such an amplifier would be one of the direct-coupled type, fed by a wide-band voltage-amplifier. (See Fig. 1).

## ANALYSIS OF COMMERCIAL SCOPES

Only a few of the commercial oscilloscopes have such an amplifier; so consequently they are generally used only in laboratories. The average serviceman's scope has its limitations, and to try to adapt it to square-wave and pulse measurements will quickly show up its shortcomings, especially as regards the amplifier section.

fier, that is, by cutting out the first amplifier stage.

Other 5-inch scopes are deficient in either the low range or the high range, or in both. This does not necessarily mean that the scopes are bad, far from it. It simply means they were never designed for this work.

## ADAPTING SCOPES TO SQUARE WAVE WORK

The simplest procedure is the following: First: Replace all coupling condensers in the vertical amplifier with larger ones. Size depends on the lowest frequency to be measured. This is important, because the reactance of the condenser (in ohms), will affect the square wave and if too large will show distortion. Second: Reduce the plate impedance of the tubes of the vertical amplifier section, by using a 2.5 to 10 M. H. iron core coil of the variable type, and a plate resistor of 2000 to 8000 ohms in series with the coil. (See Fig. 2.)

These two changes will generally improve the scope to a great extent and it is worth doing. Of course the more careful the changes made (that is, as regards setting up proper input and output circuits), the better will be the results. Any number of such similar changes can be made. For best and quick results use of the diagram shown in Fig. 3 is suggested. By employing this circuit in its entirety, in place of the one already in the scope, the instrument will have new and additional uses without impairing its regular functions.

A very important factor to keep in mind in pulse measurement work is the amplitude

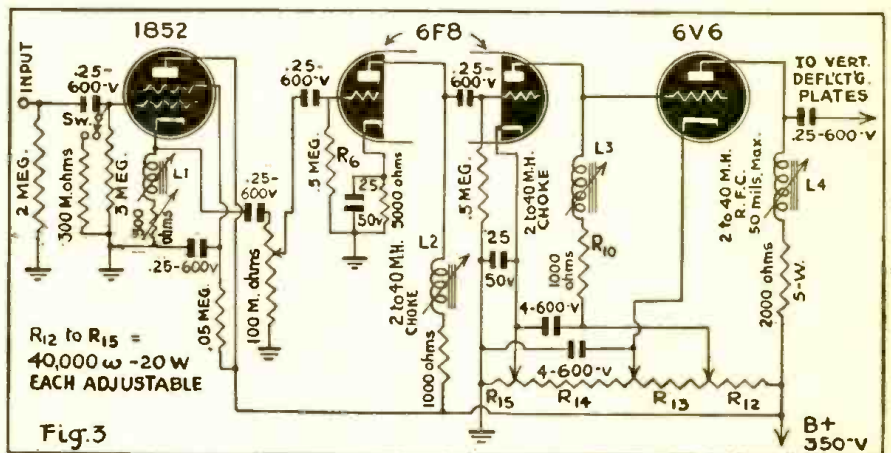

A high quality amplifier for square wave work.

As a matter of fact, all servicemen's scopes of the 3-inch and 5-inch types will not give a true picture of square waves. On the 3-inch scope the limit runs from 90 cycles to 4000 cycles. Above or below these frequencies the amplifier distorts.

Among the 5-inch scopes, the Dumont scope seems to be the only one that covers from the band 2 cycles to 18,000 cycles without distortion. In this particular scope the square-wave rage can be extended to 200,000 cycles by a slight change in procedure. This change consists of feeding the signal directly into the direct-coupled ampli-

of the voltages involved. Pulses may run fairly high in some measurements up to several hundred volts, depending on the load, so definite provisions must be made to limit the input voltage. Otherwise, the wave form will distort, due to overloading of the voltage amplifier. Perhaps the best way is to measure the square wave or pulse across a variable non-inductive resistance which can be adjusted to permit proper input to the scope.

For synchronizing, the controls are used in the same manner as for sine-wave measurements.

# RADIO ENGINEERING IN THE WAR EFFORT

By ARTHUR VAN DYCK\*

**M**OST analysts agree that the most important element in this war is aviation, that next most important is ordnance, and in third place is radio. Each of these elements has shared in the general and rapid advance in technology of recent years. As a result each has developed rapidly in capability, complexity, and degree of effect on the practice of war. Just how rapid and how great that development has been is clearly seen by comparing their present capabilities with those of World War I. Aviation and radio are similar in that both had their introduction to war in World War I, and then revealed clearly their enormous potentialities.

We are concerned here with radio only, and will find it interesting and helpful to compare its uses in World War I with those of today. To those now under forty years of age, and who, therefore, were under fifteen years of age when we entered World War I, the radio conditions of that time are unknown by personal experience, and must seem antediluvian. There was no broadcasting, no transmission of pictures by radio, and transoceanic radiotelegraphy was sporadic and unreliable. Practical radiotelephony had just been born. Even radiotelegraphy was only five years old, in the sense that only for that length of time had passenger vessels been required to have wireless and operators to be licensed.

What a contrast is presented by today's conditions! Now transoceanic radio telegraphy and telephony both are giving everyday reliable service, and broadcasting covers the earth. Television and entry into the higher-frequency spectrum are repeating the conditions of new possibilities in war which were brought to the last war by the vacuum tube and radiotelephony. New and great significance results from the application of space radio principles to uses other than communication, to which radio was confined previously, such as the now well-known radio plane detectors. The work of the radio engineer would have inestimable value if radio were used only for communication purposes in ships, planes, and tanks. With other uses added, it takes on importance second only to that of the planes and guns themselves. It seems to me correct to say that never before in the history of science, has any branch had as varied, ramified, and powerful utilization as radio does today. The radio engineer of today has a right to stick out his chest and feel important, even as he has the obligation to feel and realize his responsibility to use to the fullest advantage his opportunity for unusual service in this critical time.

As this country approached war in 1941, the radio industry encountered its first war problem in the shortage of certain critical materials upon which radio apparatus had depended from its beginning. Radio engineers met that problem so successfully that in spite of shortage and substitution, more receivers were manufactured in 1941 than in any previous year.

Then came conversion from civilian home-entertainment receiver production to the manufacture of radio apparatus for war. This was really difficult, because military

radio involves degrees of complexity, precision, and ruggedness not known in civilian radio. It meant changing engineering and factory practice from designs utilizing crude tolerances to ones of high precision, both mechanically and electrically. It meant changing from apparatus required to meet only the range of conditions between parlor and kitchen to apparatus capable of working reliably in the stratosphere and in the equatorial desert. The burden of this change fell most heavily upon the radio engineers. And well have they carried it—without adequate sleep, without furloughs, without rewards, or medals, they are doing the job.

I have not recited this story just to record what has been done so far, or to pat the profession on the back. I have done so in order to silhouette what remains to be done, because if we are to continue on to the greater tasks ahead, with maximum efficiency, we must realize where we fit in the picture, and how basically vital radio is in this war. Furthermore, to advance and improve we do not need to dwell upon the good things we have done or are certain to do, but instead we need to know the bad, and to correct them.

The new mobility of attack, on land, on sea, and in the air, is possible only by use of radio communication. The companion mobility of successful defence is dependent likewise upon radio communication. In World War I, radio communication was an adjunct; in this war it is a vital necessity. In addition, we have now the applications of radio techniques to new instruments and weapons, thereby broadening the field of radio to limits not yet clearly seen. How can realization of this situation assist toward better execution of the tasks ahead?

The task ahead is not merely the invention and development of new devices, but even more important, is wise utilization of the ones we already have. Utilization of the things we have is not in the hands of engineers alone; in fact, it is mostly in the hands of others. Therefore, it devolves upon engineers to educate those others in the facts of technical life as rapidly and forcefully as possible. In peacetime we can allow the time needed for sufficient education to percolate slowly through the minds of others involved, with any amount of accompanying confusion and loss. In war we cannot with safety allow that time or that confusion and loss.

The advances in radio are but a part of the advance of technology on many fronts. In aviation, metallurgy, chemistry, and plastics, to name only a few, the advance has been so rapid that, as in radio, the nontechnical person could not understand the implications of the early stages until the final stages had been reached. So, for example, we have had various phases of aviation unappreciated until very recently, although aviation experts have understood them for many years. Unfortunately for the world, this condition did not exist in Germany. There, in Dr. Haus-hofer's incredible Institute, and in the German Army, was full realization of the new importance of technology and a thoroughly integrated utilization of it.

There are some examples of the kind

(Continued on page 160)\*

## RADOLEK— Headquarters For Essential REPAIR PARTS



Thousands of progressive servicemen rely on Radolek for their complete requirements of repair materials. Make Radolek your dependable source for essential replacement and repair parts—tubes, condensers, volume controls, resistors, transformers, etc.—all at lowest prices.

Radolek understands service problems—gets delivery to you in double-quick time. Buying from Radolek means Greater Values, Better Service and More Profits. The big Radolek Radio Service Guide is FREE for the asking. Send for your copy today!

### RADOLEK P. A. SYSTEMS FOR EVERY REQUIREMENT



Thousands of successful Radolek P.A. installations are proof of quality, superior design and top performance. Complete systems for permanent, portable or mobile use—wide choice of microphones, speakers and related equipment. Radolek P.A. Systems give you more for your money in Performance, Styling, Dependability and Reserve Power. Select the P.A. apparatus you need from Radolek's big FREE catalog.

#### RADOLEK REPAIR SERVICE

Let Radolek repair your damaged or burned out transformers, coils, speakers, test equipment, etc. Many items cannot now be replaced and therefore repairing is the only alternative. Trained craftsmen, using precision tools and factory methods, assure perfect jobs equal to new. Write for prices or better still, send in any article to be repaired. It will be handled promptly.

**FREE!**



**SEND FOR NEW FREE  
RADIO SERVICE GUIDE**

**RADOLEK CO., Dept. C-73  
601 W. Randolph St., Chicago, Ill.**

Please send the Big FREE Radio Service Guide.

Name .....

Address .....

DEALER  SERVICEMAN  SOUND ENG

**SAVE AT RADOLEK**

\*President and Fellow, Institute of Radio Engineers, New York, N. Y.



Northern Radio Laboratory  
3927 East Lake Street  
Minneapolis, Minn.

"We have been using N.U. products since their inception. They have an aggressive merchandising plan we feel all dealers should avail themselves of. After 22 years in the radio business, we find National Union's helps have always been an asset to us.  
A. H. WOLFE

WHERE YOU FIND  
**NATIONAL UNION**  
YOU FIND BETTER  
**RADIO SERVICE**

**PREMIUM**  
*Quality*  
**TUBES**



**BATTERIES**



**CONDENSERS**

also Transmitting tubes, panel lamps, cathode ray tubes, exciter lamps, sound equipment, photo electric cells, sound accessories, dry batteries, flashlight bulbs.

NATIONAL UNION invites . . .

All radio service dealers to enjoy the benefits of the N. U. Shop Equipment Plan. The latest in tube testers and test equipment are available to you . . .

More than 60,000 completed deals prove the success of this plan. Investigate now.

Ask Your N. U. Distributor or Write



**NATIONAL UNION**  
**RADIO Corp.**  
57 STATE ST. NEWARK, N. J.

**A DIRECT-READING OHMMETER**

(Continued from page 149)

formula can be changed to

$$\frac{R_m}{R_s} = \frac{I - I_m}{I_m} \text{ and } R_m I_m = R_s - R, I_m, \text{ and}$$

$$\text{finally we get } I_m = \frac{R_s}{R_m + R_s}$$

In this last equation we have two unknowns:  $I_m$  and  $R_s$ ;  $R_m$  is unknown because it is equal to the internal resistance of the meter plus the external series or shunt resistance. We can now plot a graph giving values of current vs. values of resistance, and this graph is shown as Fig. 3.

For the purpose of simplicity and convenience the writer has chosen  $R_m$  to be equal to 10 for values of  $R_s$  from .5- to 100. Any value below .5- or above 100 makes the readings either of the current on the meter or the resistance values on the graph inadequate for all practical purposes. However, if we multiply the numerator and denominator of the right member of the last equation by 10, the values of  $I_m$  will remain the same for a new set of values ranging from 10 to 1,000. In order to accomplish this, all we have to do is increase the "internal" resistance of the meter to 100 and multiply the resistance units to be tested by 10. The equation then becomes:

$$I_m = \frac{10R_s}{10R_m + 10R_s}, \text{ which can also be translated as } I_m = \frac{R_s 10}{10R_m + R_s 10}$$

where  $I_m$  will remain the same between the values of zero and 100 when  $R_s$  and  $R_m$  are multiplied simultaneously by 10. You can therefore readily see that there is no limit to how far we can go with this procedure, if it were not for the limiting factor  $R_m$ . Because when  $R_m$  is increased above 100,000 the voltage required would have to be very high in order to get 1 ma. through the circuit. For all practical purposes the ranges shown in Fig. 3 are sufficient. It is possible, however, to measure resistance values up to 5 megohms by using  $R_m = 100,000$ , and the graph shown in Fig. 4.

The milliammeter used, as stated before,

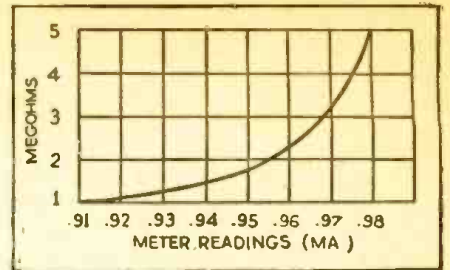

Fig. 4. Graph; range: 1 to 5 megohms.

has a 0 to 1 ma. range. The internal resistance of this meter is 27 ohms. In order to obtain a resistance  $R_m$  of 10 ohms it is necessary to shunt the 27 ohms with a 16 ohm resistance. The two resistances in parallel are equivalent to 10 ohms and the results obtained are the same as if the internal resistance of the meter was 10 ohms. It is therefore necessary to close Sw. 1 when resistors of less than 10 ohms are to be tested. It can also be seen that by shunting the internal resistance of the meter and still keeping the current in the meter at full-scale deflection, the current through the entire circuit will be approximately 2.7 ma. This will require about 300 V. of D.C. instead of a little over 100 V. In order to avoid the necessity of using a higher voltage the 90,000 ohm resistor may be short-circuited by Sw. when the 16 ohm shunt is being used.

Of course if anyone has a meter the internal resistance of which is 10 ohms or less, switches Sw. 1 and Sw. 2 can be eliminated. According to the writer's information, however, no such meter is listed in any of the manufacturers' catalogs.

There may arise in some reader's mind a doubt as to whether the scheme used for obtaining  $R_m = 10$  ohms is mathematically correct—it is! The writer has worked it out mathematically; and for the purpose used, it is exactly the same as if the internal resistance was 10 ohms. The mathematics involved are a little bit complicated. To work it out would require a lot of figuring which is beyond the scope of this article. Any radio enthusiast who would like to work this out for himself, can spend a few interesting minutes in solving this problem.

**HOW LONG WILL OUR RECEIVERS LAST?**

ACCORDING to a recent survey, apparently conducted by NBC, about 10% of the 60,000,000 sets in use in American homes last June, will be out of commission in June, 1943.

Of course the reasons for this are the usual break-downs, ordinary obsolescence, lack of replacement parts and tubes, etc.

And by the middle of 1944 it is going to be pretty bad. The estimated number of dead receivers by that time will be increasing at the rate of about 14,000 a day.

**FUTURE PROSPECT**

If the war keeps up three or four more years it looks as though the majority of homes will be without a radio. And even after the war is over it will take some time for the factories to get back into civilian production.

This prospect is serious in view of the fact that broadcasting is so vital in getting news to the people, and in providing entertainment and other morale-building programs.

Coupled with this is the fact that there is a desperate shortage of service men and it won't be easy for the home owner to get

the repairs made on his old radio.

What replacement parts will be available are going to be hard to get.

**FUTURE FM**

Even though all this has little or nothing to do with FM at the present time, it will be of importance after the war.

Right now of course the AM stations are doing an excellent job; but when the war is over and the majority of present receivers are in the dead dodo class, the listener will be on the lookout for the latest, and the latest will be FM receivers.

The public will probably go overboard for these quality receivers; and especially in view of the fact that the trend might be to keep the powerful AM stations to cover the rural areas, and place the city locals on the FM band.

This all makes sense; and may probably be considered a little revolutionary, but the war is bringing about a lot of changes, and a few in radio broadcasting and receiving are bound to come. When something comes along that is a change for the better—such as FM is—the chances are it will be promptly accepted by the listening public.



**PHOTOELECTRIC MEASUREMENT OF COLOR**

INTEREST in the measurement and quantitative specification of color has grown rapidly in recent years because of the increased use of numerical designations of color in purchase specifications for paint, paper, ceramics, and other materials, and because of the increased attention given to the appearance of many finished articles sold on the market. The photoelectric method of measuring color is simple and direct, and its possibilities have not been examined until recently. Although new filter-photocell methods for measuring color have been announced frequently during the last 15 years, measurements have shown that the filters and photocells in most of these instruments were not properly chosen, as regards spectral character, for making the purported measurements of color.

In Circular C429, recently released by the Department of Commerce, Richard S. Hunter describes a number of types of color measurements which can be made with any device having a source, three filters, and a photocell. Because the resultant three combinations of source, filter, and photocell are nearly equivalent spectrally to the ICI standard observer for colorimetry, measurements with them give valuable quantitative color information. However, as it was not possible to obtain combinations exactly equivalent to the ICI observer, these measurements are not in exact agreement with colorimetric values computed from spectrophotometric data. The suggested photoelectric combinations are nevertheless well suited for measuring the color differences between spectrally similar specimens.

**STATEMENT OF THE OWNERSHIP, MANAGEMENT, CIRCULATION, ETC., REQUIRED BY THE ACT OF CONGRESS OF AUGUST 24, 1912 AND MARCH 3, 1933.**

Of Radio-Craft Incorporating Radio & Television, published monthly at Springfield, Mass., for October 1, 1942.

State of New York }  
County of New York }

Before me, a Notary Public in and for the State and county aforesaid, personally appeared Hugo Gernsback, who, having been duly sworn according to law, deposes and says that he is the editor of Radio-Craft, Incorporating Radio & Television, and that the following is, to the best of his knowledge and belief, a true statement of the ownership, management (and if a daily paper, the circulation), etc., of the aforesaid publication for the date shown in the above caption, required by the Act of August 24, 1912, as amended by the Act of March 3, 1933, embodied in section 537, Postal Laws and Regulations, printed on the reverse of this form, to wit:

1. That the names and addresses of the publisher, editor, managing editor, and business managers are: Publisher, Radercraft Publications, Inc., 25 West Broadway, New York, N. Y.; Editor, H. Gernsback, 25 West Broadway, New York, N. Y.; Managing Editor, none; Business Managers, none.

2. That the owner is: (If owned by a corporation, its name and address must be stated and also immediately thereunder the names and addresses of stockholders owning or holding one per cent or more of total amount of stock. If not owned by a corporation, the names and addresses of the individual owners must be given. If owned by a firm, company, or other unincorporated concern, its name and address, as well as those of each individual member must be given.) Radercraft Publications, Inc., 25 West Broadway, New York, N. Y.; H. Gernsback, 25 West Broadway, New York, N. Y.

3. That the known bondholders, mortgagees, and other security holders owning or holding 1 per cent or more of total amount of bonds, mortgages, or other securities are: (If there are none, so state.) None.

4. That the two paragraphs next above, giving the names of the owners, stockholders, and security holders, if any, contain not only the list of stockholders and security holders as they appear upon the books of the company but also, in cases where the stockholder or security holder appears upon the books of the company as trustee or in any other fiduciary relation, the name of the person or corporation for whom such trustee is acting, is given; also that the said two paragraphs contain statements embracing affiant's full knowledge and belief as to the circumstances and conditions under which stockholders and security holders who do not appear upon the books of the company as trustees, hold stock and securities in a capacity other than that of a bona fide owner; and this affiant has no reason to believe that any other person, association, or corporation has any interest direct or indirect in the said stock, bonds, or other securities than as so stated by him.

5. That the average number of copies of each issue of this publication sold or distributed, through the mails or otherwise, to paid subscribers during the twelve months preceding the date above shown is \_\_\_\_\_ (This information is required from daily publications only.)

(Signature of publisher)

H. GERNSBACK

Sworn to and subscribed before me this 28th day of Sept. 1942.

MAURICE COYNE, Notary Public  
(Commission expires March 30, 1944.)

**HALLICRAFTERS ★ HALLICRAFTERS**



**COMPLETE STOCKS**

★ We still have large stocks of receivers, 2 1/2 meter equipment, meters, tubes, transformers, resistors, condensers, panels, chassis, and radio parts of all sorts. We sell and rent code teaching equipment. Your orders and inquiries invited.

**LET'S ALL PITCH IN!**

WE CAN all help win this war by selling our government the communications receivers and equipment they need quickly and in sufficient quantities.

That is the reason we are paying highest cash prices for used communications equipment.

When this war is over you will be in the market for new equipment and by taking advantage of our offer to purchase your present equipment at highest cash prices you will be in a position to buy new and better equipment than you now own.

Write, telephone or telegraph us description of your used communications receivers, transmitters and parts of standard make; you will be paid cash immediately without bother or red tape. We are particularly interested in *Hallicrafters*.

We also have a store at 2335 Westwood Blvd., West Los Angeles, Calif.

**Bob Henry, W9ARA**  
**HENRY RADIO SHOP**  
BUTLER, MISSOURI

"WORLD'S LARGEST DISTRIBUTOR OF COMMUNICATIONS RECEIVERS"

**MOLECULES GET TIRED**



Dr. N. C. Beese, research engineer at a Westinghouse laboratory, is shown measuring the amount of "fatigue" in a piece of fluorescent glass. This fatigue phenomenon occurs when the glass is exposed to constant and continuous ultraviolet radiations. The

molecules of the glass which are responsible for the fluorescence, get "tired" and lose a great deal of their ability to fluoresce. However, if left for a "rest" in the dark they regain their original strength and can fluoresce once more.

ARE

# Coils

YOUR PROBLEM?

For many years Meissner Coils have been the accepted standard by engineers who insist upon high quality performance. Meissner precision coil construction never varies... they are the best that engineering research and modern production methods can make.

When you specify a Meissner Coil you have the assurance of long, trouble-free operating life backed by a name that is synonymous with precision-built products.

Coils illustrated and described represent only a few of the complete Meissner Coil line.

See your nearest Meissner distributor today.

**Meissner**

MT. CARMEL, ILLINOIS

"PRECISION-BUILT PRODUCTS"

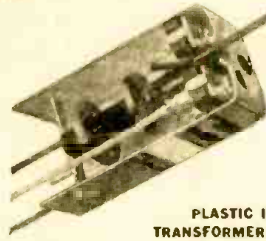

PLASTIC IF TRANSFORMERS

The most popular replacement types. Compact in size, 1 1/4" square, 2 1/4" high. Available in all frequencies from 175 kc. to 456 kc. List price \$1.10 each.



UNIVERSAL ADJUSTABLE COILS

Adjustable—Inductance Ferrocart (Iron Core) coils will replace the broadcast band coils in practically any receiver. 3 types available. Antenna, RF, Oscillator. List price \$1.38



COMPACT ANTENNA—RF COILS

Ideal units for replacement in compact midset or auto Radio sets. Coils wound on form "W" in diameter, 1 1/4" long. List price, either type, Antenna or RF, 50c each.

## RADIO ENGINEERING IN THE WAR EFFORT

(Continued from page 157)

of thing which we in radio need to do in our own industry, to improve our integration, co-ordination, and utilization of technical possibilities, and which can be mentioned in public forum. One is the utilization of the broadcasting system for public information, instruction, and control in the event of air attack. So far this vast system has not been arranged for such use at all, in spite of its obvious availability and effectiveness. Let us examine this particular situation from the integrated technical viewpoint, which of course includes radio, military, and psychological factors, and see what conclusion would be reached.

Preparation of protection against air at-

tack on this country has the following factors.

1. Attack will come unexpectedly.
2. Attack is almost certain to include new elements of attack (because this is past practice of the enemy in new attacks).
3. Rapid distribution of information to organized workers and the public regarding new elements of attack can mean the difference between catastrophe and successful resistance.
4. Instant calling or signaling to certain vital organized workers (such as auxiliary firemen and home guards) is necessary if they are to be of service quickly, as they must be to be effective.
5. The American people are not like

(Continued on page 188)

## PRESENT STATUS OF DIATHERMY

READERS will recall how the problem of interference was discussed, in the columns of *Radio-Craft*, and how after Pearl Harbor it was found that the Japs were using these ultra-short-wave machines to communicate intelligence to Nippon. They were not detected locally at first, owing to its being considered part of local hash, but when all amateurs had to go off the air, and inland communications also, except the military, investigators were able to track them down.

The Japs were smart enough to use the "skip-distance" effects of U.H.F. radiation.

All machines, no matter in whose hands they are, had to be registered last June. Therefore it is now *ipso facto* evidence of espionage if one is found using an unregistered machine.

An interesting sidelight of the registration showed that there are some 75,000 diathermy machines in the New York area alone. So it can be seen what juicy possibilities there were for spies and saboteurs. Fortunately, the watchful eyes of the F.B.I. and the F.C.C. nab the offenders right off the bat.

However, it is well known and taken for granted that diathermy machines must be kept in operation for the benefit of those needing treatment. After all, maintenance of good health is part of the home front defense job.

Dr. Alfred N. Goldsmith, inventor and scientist, has pointed out that "uncontrolled diathermy is bound to become a menace to radio and television receiver enjoyment." "When you see streaks flicking across the screen of your television set," said Dr. Goldsmith, "ten to one it is caused by diathermy; perhaps your own family doctor in the next block is unknowingly the cause. The family doctor would not send information over his diathermy instrument to an enemy of his country, but he may be unconsciously causing interference in your receiver by what engineers call *leakage radiation*. In fact, he may be interfering with your favorite radio program even though his instrument is miles away.

"Of course we cannot abolish diathermy, but we engineers should supervise its use, not medically (leave that to the medical men) but electrically, to end interference. Every radio factory in the country uses dozens of shielded rooms in which to test sets before they are marketed. All diathermy should be applied in small rooms surrounded with copper mesh like the screen door. That is one thing the radio man can teach the diathermy specialist.

"And in the end he would find such consideration for listener-patients to be ethical, courteous, and just plain good business."

Research by the electrical and radio industry has shown that these machines can be utilized for therapeutic purposes, provided their radiation is kept from interfering with radio signals. This can be done by shielding. Shielding of the entire equipment, the patient, and the power supply lead-in. This means of course the use of copper and similar wartime-scarce metals, which complicates the problem, but we can count on Yankee ingenuity to work out a satisfactory solution before long.

And even if the shielding be accomplished, it is necessary that the machine be inoperative when the door of the shielded room is opened.

The radio industry, the F.C.C., the med-

(Continued on page 188)

# TWENTY WAYS TO USE THE "ELECTRIC EYE"

By C. W. PALMER

*One of the most interesting fields for experiment—by the radio fan—is the use and application of photoelectric cells. While these circuits are not new, they will give a good start to those interested.*

**T**HE photoelectric effect was discovered in 1889 by Hallwachs—who found that crystals of fluorite not only became electrically charged by heat, but also by exposure to sunlight or to the light of an electric arc, both of which are rich in ultra-violet light. It has been scientifically demonstrated that every material is electrically sensitive to light—conductors and insulators alike all emit electrons when exposed to a suitable source of light. Some materials exhibit marked photo-sensitive effects, while others are notably insensitive.

There are many practical uses in everyday life for photoelectric cells (the devices which operate by means of photoelectric effects). In industry they are used for counting, sorting, regulating artificial lighting, protecting workers, and many other such tasks—in the home they are applied to opening doors, turning on lights, announcing guests, smoke and fire alarms, burglar alarms, etc.

Photoelectric cells may be divided into five general classes:

The selenium cell—or photo-conductive cell which is perhaps the oldest practical photo-cell. The fact has been known since 1851 that the resistance of selenium decreases when light falls upon it—though the effect was not understood or applied until about 1890.

Photo-voltaic cells—or light batteries as they are sometimes called. They are of the wet type having electrodes in a suitable liquid. They produce their own voltage when light falls on them.

The photoelectric tube—which consists of an alkaline covered cathode and an anode enclosed in a glass or quartz bulb and either evacuated or filled with an inert gas. By means of a "B" battery a current is caused to flow from cathode to anode and this current is controlled by the amount of light impinging on the cathode.

Semiconducting layers of cuprous oxide similar to the rectifiers used in radio work form the fourth type. This type resembles the light battery in that it produces a current when illuminated.

Still another type consists of a flat metal plate with a suitably sensitized surface which becomes a generator of electricity when exposed to light. This type is known as the photronic cell.

The last two types are generators, in that they convert light into electricity directly, without an intermediate source of current.

## HOW THEY ARE USED

The photo-sensitive cell—whichever type is chosen—may operate a sensitive magnetic relay and so accomplish electrical or mechanical tasks controlled by a source of light. Some types produce current differences sufficient to actuate the relays directly, while others require amplifiers to increase the change in current sufficiently to operate practical relays. (With sufficiently sensitive relays, any type could work directly—but the relays would be too costly and too delicate for practical use.)

## THE CIRCUITS

The circuit in Fig. 1 shows how a selenium cell is connected to an amplifier tube. This type of cell can actuate a relay directly and, in fact, it is usually used in this way. The device shown is a rather specialized use of the cell for indicating the intensity of light—such as the light in a room. It is used (practically) for regulating the amount of artificial light used. The circuit may also be applied to other control applications where unusual sensitivity is needed.

The circuit in Fig. 2 illustrates the normal way of connecting up a photronic cell to other equipment. Fig. 3 shows two ways of connecting the photolytic cell (this is a photovoltaic cell) where uninterrupted light is used to actuate it and also when a modulated light—such as that found in talking movies—is the controlling means.

The circuits in Figs. 4 and 5 are practical ways of connecting gas-filled or "hard" photo-tubes. Fig. 4 is known as a "forward" circuit in that when the tube is dark, a minimum plate current flows and the relay is inoperative. Then when light falls on the cell, plate current of the amplifier increases and actuates the relay. Fig. 5 is a "reverse" circuit in which maximum plate current flows when the cell is dark and a decrease

occurs when the cell is illuminated. Thus the relay opens when light falls on the cell. The contacts on the relay may be selected to open or close the circuit for either forward or reverse arrangements.

It is interesting to note that A.C. is applied to both the photo-tube and amplifier—as both act as rectifiers.

Certain radio tubes exhibit marked photoelectric effects and may be used by the experimenter in this field with fine success. We refer particularly to the type 45 with the common "black-plate." The grid is left floating—by cutting off the grid prong, as shown in Fig. 6 and the plate is connected in series with a battery to the relay or an amplifier tube. A tube should be chosen which is clear at the top so that light can reach the plate easily.

## HOW TO USE THE PHOTO-CELLS

There are numerous interesting experiments that can be performed with photo-cells connected in the ways described. For example, Fig. 7 shows how a bell or alarm can be sounded by the rising sun in the morning. By reversing the relay contacts, a lamp or light can be turned on when the sun sets. Fig. 8 shows how a practical

*(Continued on following page)*

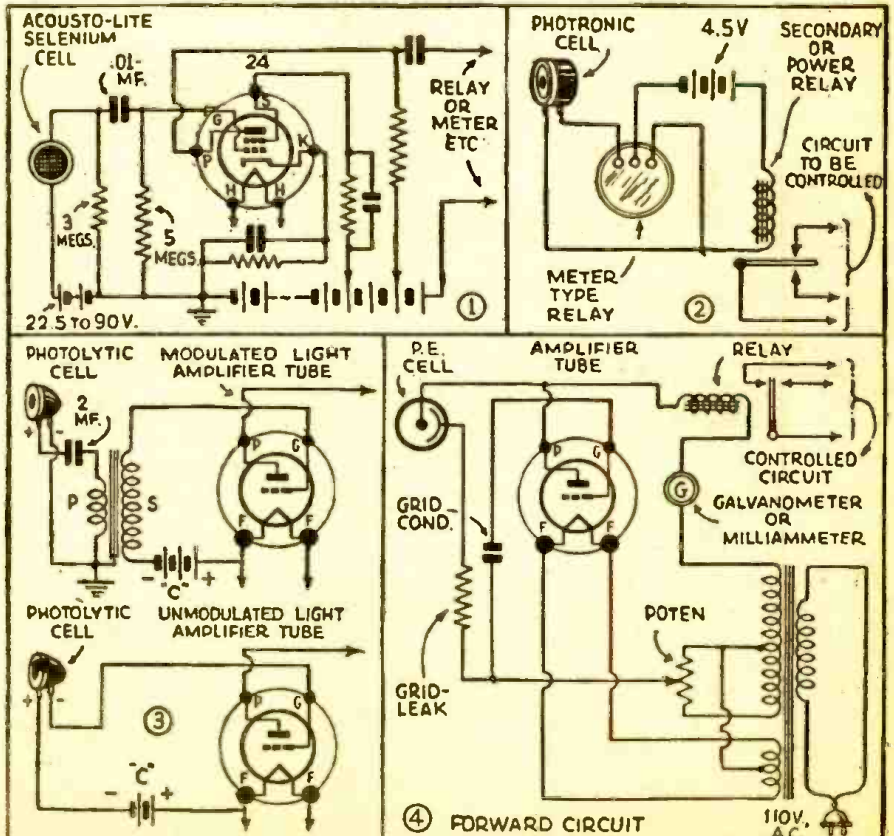

These diagrams show several interesting applications of the standard types of photo cells. The selenium cell is also known as photo-conductive; the photolytic as photo-voltaic. These circuits constitute an excellent guide to hooking up phototubes.

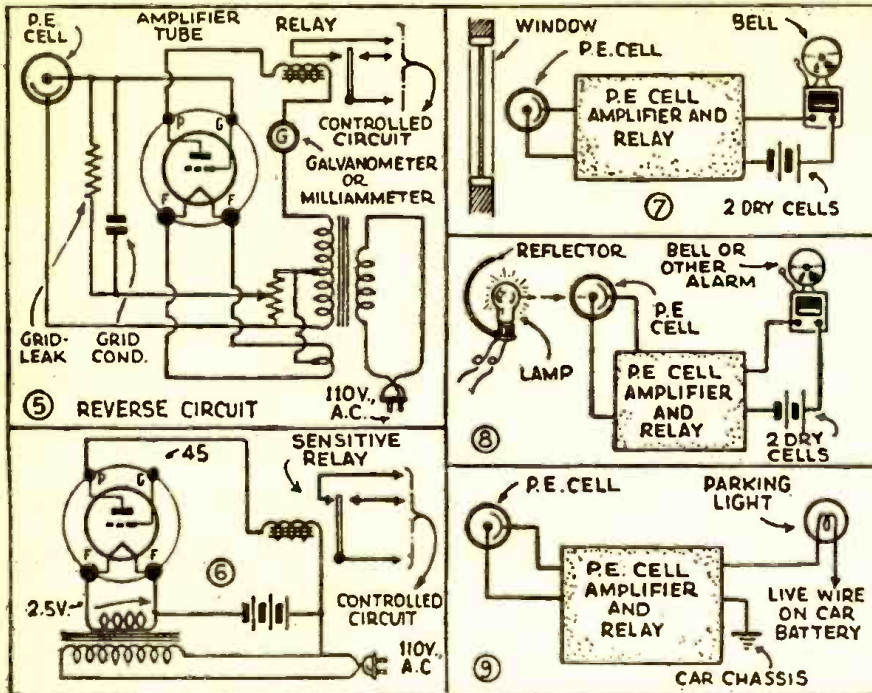
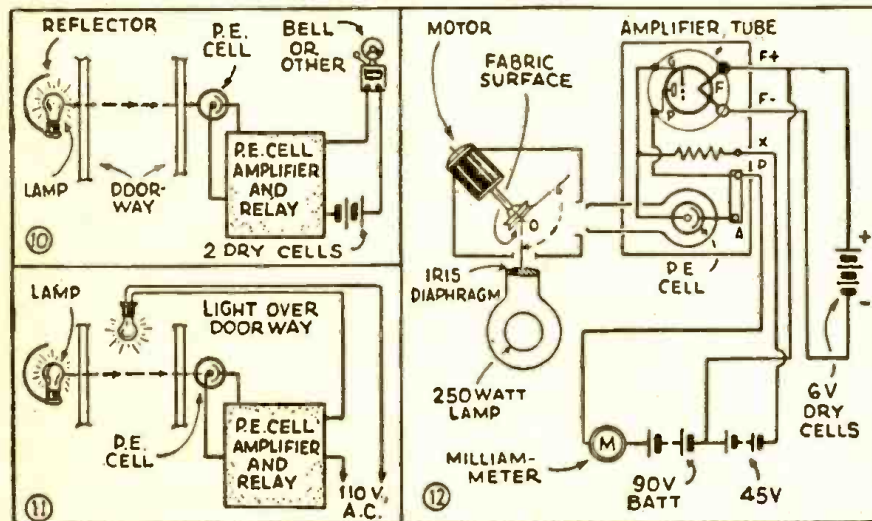

Fig. 5 shows a "reverse circuit" that is, one in which maximum plate current flows when the cell is dark, and minimum current flows when the cell is illuminated, thus causing the relay to open when light falls on the cell. Fig. 6 shows a 45 tube which has a black plate (the type that exhibits photo-electric effects) which may be used by the experimenter with fair success. The grid prong is cut off at the tube base as shown in the diagram.



The applications shown in Figs. 10 and 11 show how visitors can be announced and welcomed by photoelectric cells. Fig. 12 shows one of the industrial applications, such as testing the lustre of cloth.

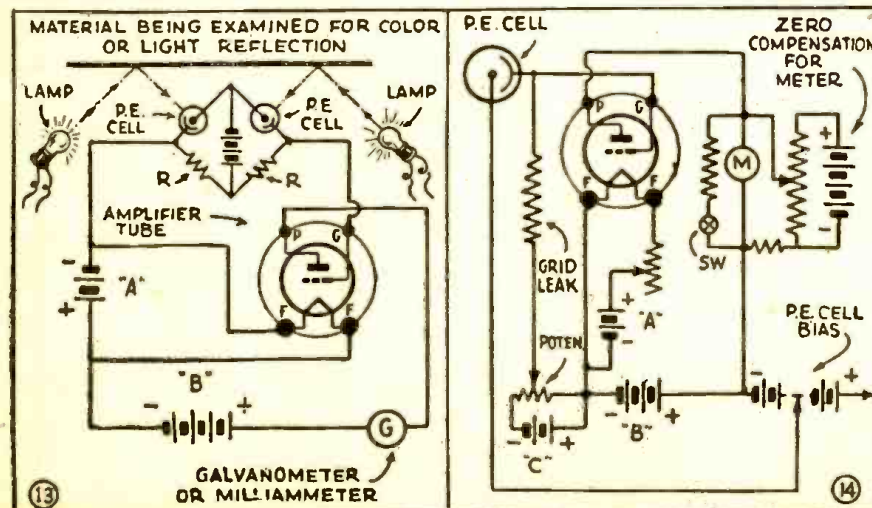

Fig. 13 shows how two cells are employed for comparing colors or light intensities. The cells are connected as two arms of a Wheatstone bridge and any difference in light is recorded by the cells; causes an unbalance to occur which is recorded on the milliammeter. The set-up in Fig. 14 is a practical device for measuring light intensity.

(Continued from previous page)

burglar alarm is made up. In this application, of course, it is preferred to use an ultra-violet or infra-red ray which is not visible to the human eye but will actuate the P.E. cell. An arlight or a strong spotlight with a sheet of thin hard-rubber over the front is fine for this "invisible light" (sometimes called "black" light).

The arrangement in Fig. 9 shows how a parking light can be turned on a parked car either by the headlights of another approaching car or by the setting sun. For the former use, the photo-sensitive cell should be mounted low on the car—in the direct path of the beam of an approaching vehicle. Two are needed—one for the front and one for the back.

The applications in Figs. 10 and 11 show how visitors can be announced and welcomed by P.E. cells. The arrangement in Fig. 10 shows a spot of light across the doorway which is interrupted by the visitor thus ringing the door bell automatically. The one in Fig. 11 automatically turns on a light over the door when anyone approaches it.

COMMERCIAL APPLICATIONS

The circuits in Figs. 12 and 15 show some interesting industrial applications of the photocell which show the methods used and are thus of interest to the experimenter who may apply them to his own needs.

Figure 12 is a method of testing the lustre of fabrics by revolving them very fast in the path of a light beam and registering the reflected light impinging on a P.E. cell. A sample of the cloth is secured to the disc on the motor. Figure 13 shows how two cells are employed for comparing colors or light intensities. The cells are connected as two arms of a Wheatstone bridge and any difference in the light recorded by the cells causes an unbalance to occur between the cells which is recorded on the milliammeter. Different colors reflect differently. This arrangement is also used for examining paper on rolls for breaks or thin spots, etc., and for many other applications.

The set-up in Fig. 14 is a practical device for measuring light intensity. This is applied to the control of light in industrial plants—to the examination of translucent objects and to similar commercial uses. One of these devices can be applied to photography as an experimental "exposure" meter. A battery is connected with a suitable high variable resistance to oppose the plate current from the "B" battery, so that the milliammeter reads zero when the cell is dark.

For certain specialized tasks, the speed of operation is an essential factor. Ordinary circuits such as those given above are not quick enough in action to serve the purpose. Such applications as the control of hot steel to respond to the radiant energy of the bars—to the control of package wrapping machines to insure the correct register and the printed matter on the wrapper, and for aligning properly the end crimp on tooth paste tubes with the printed matter on the tube—require unusual sensitivity and greater speed than normal. The circuit in Fig. 15 shows a commercial unit which has the necessary speed. The P.E. cell actuates an amplifier of the triode type and this in turn triggers a grid-glow relay tube into action.

The applications and methods presented here are by no means a complete summary of the possible uses for P.E. cells. Such a survey would require a complete volume to cover, in even a sketchy manner. However, a few of the most interesting applications for the experimenter and radio enthusiast are outlined. They may help those who are interested to apply these interesting devices to their own particular needs. The values

(Continued on page 187)

**CENSORSHIP VS. RADIO PROGRESS**

(Continued from page 135)

must be killed, even after it had been pointed out that the Nazis and Japanese have used and are using the identical device. The censor made the weak excuse that the American device could perhaps be used in "a different manner" than similar devices, now used by the enemy. This certainly again is under-estimating the technical intelligence of our two major enemies, who in the past have shown that when it came to radio devices, they certainly could match anything that we have.

Other censors act in this pattern because, as a rule, they do not have the technical training required to distinguish between what is new and what is ancient. Magazines of the type of RADIO-CRAFT, as is well known, are read closely in all foreign countries. Most first-class radio magazines have a good-sized foreign subscription list. This brings us to the "export" censor, who knows all this quite well; yet he has banned RADIO-CRAFT back numbers, going back as far as 1940, despite the fact that such copies have been sent all over the world before Pearl Harbor. So what happens? We have a long list of items which we must tear out of copies of old magazines before they are allowed to be shipped abroad! For some reason, the same censor seems to have his face set dead against anything whatsoever with the words "frequency modulation" in it. Yet, if there is one radio subject on which there has been published a veritable torrent, not only here, but abroad, it is the subject of frequency modulation. Once Professor Edwin H. Armstrong had explained the principles and technical data of frequency modulation, there was little that any one could add to it, except routine developments; consequently, articles which RADIO-CRAFT has been publishing on the subject cannot in any way be considered revolutionary news. They are merely routine observations by various writers, servicing information, etc.

The same is the case of television on which no major recent developments have been made and certainly not much practical information has or can be published because, for the time being, television, for all purposes, stands still. Nevertheless, the export censor does not allow certain articles on television to leave the country either, even if the information is well known in every country the world over.

Then there is the matter of U. S. patents which are under a particularly powerful taboo by the censors. Now then, as every one knows, the *United States Patent Gazette* publishes all new patents each and every week so anyone interested in any patent whatsoever can see and read for himself. Wisely, the patent office often refrains in war times from publishing certain inventions known to have a war aspect. That leaves the other routine inventions open for the inspection of all. The export censor may tell you that the *Patent Gazette* can probably not be sent abroad, but that is not the point. If an Axis Intelligence operator sees an invention which he thinks has merit to his country, he will find ways and means to send it out of the U. S.—censorship or no censorship. The censor himself knows this well but he will tell you that he must make it as tough as possible for the enemy so that no information of this type shall leave the country.

All of this is indeed, beside the point, because we doubt that there is anything printed in the *Patent Gazette* vital to the enemy; and, for this reason, patent information printed by a magazine only copies such material from the *Patent Gazette*; there-

fore it can do little harm elsewhere.

We appreciate the fact that perhaps we have not been at war long enough so that the various censors can distinguish between military and non-military technical information. The simple remedy seems to lie in a technical censorship board who intelligently can deal quickly with a technical problem whenever it comes up; and that is really all that the technical publishers of America desire.

**SEVEN NEW RADIO TUBES**

(Continued from page 151)

individual tubes, or by utilizing a combination of these two methods.

TABLE VI—6AG5  
R.F. Amplifier

Heater Voltage (A.C. or D.C.)	6.3 volts		
Heater Current	0.3 amps.		
Plate Voltage	300 max. volts		
Screen Voltage	150 max. volts		
Plate Dissipation	2 max. watts		
Screen Dissipation	0.5 max. watt		
Typical Operation and Characteristics—Class A1 Amplifier:			
Plate Voltage	100	125	250 volts
Screen Voltage (Grid No. 2)	100	125	150 volts
Cathode-Bias Resistor	100	100	200 ohms
Plate Resistance (approx.)	0.3	0.5	0.8 megohm
Transconductance	4760	5100	5000 micromhos
Grid Bias for Plate Cur. = 10 $\mu$ amp.	-5	-6	-8 volts
Plate Current	5.5	7.2	7 milliamp.
Screen Current	1.6	2.1	2 milliamp.

TABLE VII—6J6  
A.F. Amplifier

Heater Voltage (A.C. or D.C.)	6.3 volts		
Heater Current	0.45 amps.		
Plate Voltage	150 max. volts		
Plate Dissipation (each unit)	1.5 max. watts		
Characteristics—Class A1 Amplifier—Each Unit			
Plate Voltage	100 volts		
Cathode Bias Resistor*	50** ohms		
Plate Current	8.5 milliamp.		
Amplification Factor	32		
Plate Resistance	6000 ohms		
Transconductance	5300 micromhos		

R-F Power Amplifier and Oscillator—  
Class C Telegraphy

D-C Plate Voltage	150 max.	volts
D-C Grid Voltage	-40 max.	volts
D-C Plate Current (per unit)	16 max.	milliamp.
D-C Grid Current (per unit)	8 max.	milliamp.
D-C Plate Input (per unit)	2.25 max.	watts
Plate Dissipation (per unit)	1.5 max.	watts

Typical Operation at Moderate Frequencies in  
Push-Pull—Both Units\*\*\*

(Key-down conditions per tube without modulation)		
D-C Plate Voltage	150	volts
D-C Grid Voltage	-40	volts
From a fixed supply of	-10	volts
From a grid resistor of	625	ohms
From a cathode resistor of	220	ohms
D-C Plate Current (approx.)	30	milliamp.
D-C Grid Current (approx.)	16	milliamp.
Driving Power (approx.)	0.35	watt
Power Output (approx.)	3.5	watts

\*Under maximum rated conditions, the resistance in the grid circuit should not exceed 0.5 megohm with cathode bias. Operation with fixed bias is not recommended.

\*\*Value is for both units operating at the specified conditions.

\*\*\*Approximately 1.5 watts can be obtained

**RADIO**

CATALOG NO. 50

164 PAGES  
SETS-PARTS  
SUPPLIES  
FLUORESCENT

*Burstein Applebee Co.*

**BIG FREE CATALOG**

EVERYTHING IN RADIO

Sets, parts, supplies, public address systems, amateur equipment, testers, kits and fluorescent lighting at lowest prices. Huge stocks, bought months ago ready for shipment the same day your order is received. The Defense Program is making big demands on our industry but because of our advance buying we are able to fill your orders promptly and efficiently.

**PACKED WITH VALUES!**

**BURSTEIN-APPLEBEE COMPANY**

1012-14 MCGEE STREET, KANSAS CITY, MISSOURI

**LEARN CODE** the way you'll be using it by **SOUND**



The best way to learn to read code is by listening to code. The best way to learn to send code is by hearing your own sending received back to you. With the new All-Electric Master Teleplex Code Teaching Machine, you learn code the natural, easy, fascinating way. Only instrument ever produced which records your sending in visible dots and dashes—then SENDS BACK your own key work at any speed you desire. There are NO PERFORATIONS—NO INK. Far superior to anything ever developed... a marvel of simplicity. That's why practically every school teaching code uses TELEPLEX. We furnish complete course, lend you All-Electric Master Teleplex, give you personal instruction with a MONEY BACK GUARANTEE—all at an amazingly low cost per month. Write today for FREE catalog #12. No obligation.

**TELEPLEX CO.,** 107 HUDSON ST. JERSEY CITY, N. J.

**Complete Plans**

For Building Useful and Practical Things at Home. Each issue of Popular Homecraft is crammed with plans for making such beautiful and useful things as: Furniture, Bero Houses, Lamps, Outdoor Garden Furniture, Candle Equipment, etc. Covers lathe work, tooling, wood-working, leathercraft, copper. You'll find "how" to make almost everything from the pages of Popular Homecraft. Scores of drawings and photographs make every step simple as A B C. A real "How-To-Do-It" magazine.



Six Months' Trial \$1.00  
Send \$1.00 today for trial six months' subscription Money Back If Not Delivered.

**POPULAR HOMECRAFT**  
937 Palmolive Building Chicago, Ill.

**Trial 6 Months \$1.00**

**OPPORTUNITY AD-LETS**

Advertisements in this section cost 15 cents a word for each insertion. Name, address and initials must be included at the above rate. Cash should accompany all classified advertisements unless placed by an accredited advertising agency. No advertisement for less than ten words accepted. Ten percent discount six issues, twenty percent for twelve issues. Objectionable or misleading advertisements not accepted. Advertisements for January, 1943, issue must reach us not later than December 10, 1942.

Radio-Craft • 25 W. B'way • New York, N. Y.

RADIO SERVICEMEN AND EXPERIMENTERS SEND for our giant radio catalogue. Save dollars. United Radio Co., (10001) Newark, N. J.

OSCILLOSCOPE AND OTHER RADIO PARTS wanted for cash. Send list with prices to John Hart, 1123 Broadway, New York, N. Y.

FOR SALE—Equipment. Stock. All's Radio, 10-11 49 Avenue, Long Island City.

BURNED OUT RADIO TRANSFORMERS CAN BE salvaged. We rewind all types of transformers. Write for list. Transformer Rewinding Service, 1309 West Hill, Valdosta, Georgia.

when the 6J6 is used at 250 mc. as a push-pull oscillator with a plate voltage of 150 volts, with maximum rated plate dissipation and with a grid resistor of 2000 ohms common to both units.

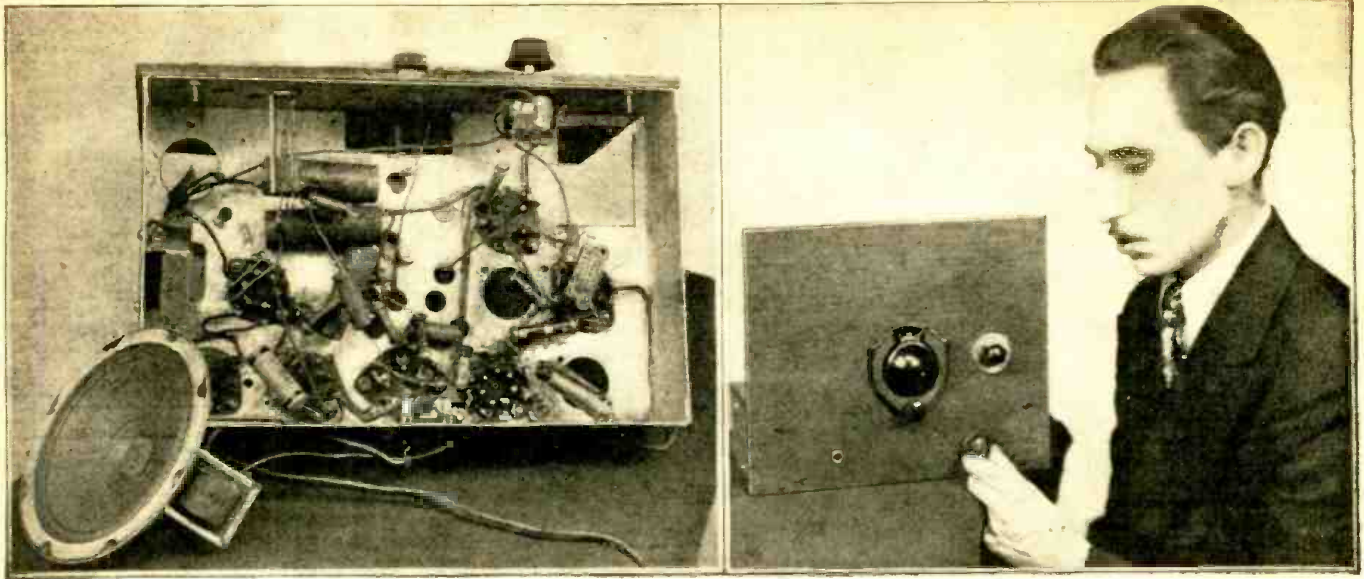

The photo on the left shows the radio made of junk parts; that on the right shows the author tuning-in.

# THE VICTORY RECEIVER

By ISADORE SAMKOFKY

ONE of the members of our radio club recently wrote us that he is in the armed forces of our government and desiring to improve his code needed an inexpensive short-wave receiver to do so. I was appointed to take care of this matter. At first, I decided to buy him a used receiver, but soon discovered that it is next to impossible to purchase one. My next idea was to build one, but again we could not buy some of the necessary parts. This led me to the pile of radio junk I have been gathering for the past several years, out of which came what I call the "Victory Receiver." This set was built with parts obtained from a dozen receivers, both broadcast and short-wave. I did not find it necessary to purchase a single part!

## ASSEMBLY

The chassis which I used was covered with rust, but made to look like new with some steel wool, a brush and paint, and plenty of elbow grease. The tuning condenser was one used in a T.R.F. receiver about a decade ago. It consisted of two gangs and its capacity was .00035 mfd. I removed all but four rotor and five stator plates. As the plates which were removed were of aluminum they were contributed to the local junk yard and are being used probably in the construction of an airplane by now. The trimmer condensers were also removed. These operations converted the tuning condenser to .00014 mfd.

The regenerator control R-2, is a 25,000 ohm potentiometer, such as is used in thousands of AC-DC broadcast receivers as volume controls. It was slightly noisy, but this was remedied by connecting an 8 mfd. 150-volt filter condenser C-13, from the screen grid of the 6J7 detector tube to ground making its action entirely smooth and noiseless.

The filter condensers C-11 and C-12 are 20 and 40 mfd. 150 volts. These were salvaged along with the filter-choke from an AC-DC receiver. The high capacity of

the filter condensers insure operation with extremely little hum.

The P.M. speaker was repaired with some speaker cement and it sounded pretty good.

## TUBES USED

There are five tubes used and a ballast. The tubes are a 6J7 detector, 6F7, untuned radio frequency and 1st audio, 37 2nd audio, 25L6 power output, 25Z5 rectifier and a BM49B ballast tube. The ballast tube has an approximate resistance of 175 ohms. An AC-DC line cord of same ohmage can be used instead, if desired.

Each of the tube types can be replaced by similar ones if those listed are not on hand. For example, the 6F7 can be replaced by a 6P7. The 6J7 by a 6J7G, 6J7GT, 6C6 or 77. The 37 can be replaced by a 76, 6C5, 6C5G, 6J5, 6J5G, etc. If a 25L6 is not handy, use a 25L6GT, 25L6G, 25A6, 43, etc. The 25Z5 is replaceable with a 25Z6. But remember that the output transformer must match the output tube in order to get maximum output, without distortion.

## USE OF THE 6F7

The 6F7 is a dual purpose tube. The pentode-section was utilized as an untuned radio frequency stage. There are several reasons to warrant its use. It eliminates "dead-spots," caused by the absorption effects on the antenna, and it eliminates the use of an antenna coupling condenser. The tuning dial can be calibrated and stations will always come in at the same dial setting. It also helps to make the regeneration control much smoother, and little adjustment is necessary when tuning from one station to another.

The pentode section of the 6F7 was inductively coupled to the 6J7 detector. This method of coupling insures better sensitivity. Any other method of coupling between the R.F. tube and the detector brings plate voltage to the tuning condenser and grid-leak, and causes a distinct noise.

Connections and part values must be correct in wiring up the 6F7. The grid-cap is connected to the antenna post. A 62,000 ohm resistor R-5, is soldered from antenna post to ground. Cathode bias is obtained by connecting a 400 ohm resistor R-4, from cathode to ground. This is shunted by a 0.1 mfd. 400-volt, paper condenser C-5. The pentode plate is connected to the number 1 terminal of the coil. The pentode screen-grid is connected to the number 2 terminal of the coil. A 100,000 ohm resistor R-7, is connected from triode plate to pentode screen-grid. A .01 mfd., 400 volt paper condenser C-7, is connected from triode plate of 6F7, to the grid of the 37 tube. A 100,000-ohm resistor R8 is connected from triode plate of 6F7 to the plate of the 37 tube.

Resistance-capacity coupling is used to couple the plate of the 6J7 to the triode grid of the 6F7 tube.

## 6J7 DETECTOR

The 6J7 is used as an electron-coupled detector. A 1-megohm grid-leak R-1, is used, shunted by a .0001 mfd. mica condenser C-3. The cathode of the 6J7 is connected to the number 4 terminal of the coil, and the stator of the .00014 mfd. tuning condenser C-1, connected to the number 3 terminal. The number 5 terminal is grounded. A beam-power 2516 was used as the output tube. This puts plenty of "sock" in the P. M. speaker. Cathode bias was obtained by connecting a 250-ohm 1-watt resistor R-13, to ground. This is shunted by a 10-mfd., 25-volt filter condenser C-9.

A 25Z5 is utilized as a half-wave rectifier. In order to cut down line-noise a 0.1 mfd. 600-volt tubular paper condenser C-10, was connected from plate of the 25Z5 to ground.

## REGENERATION

Getting back to the regeneration control, a 25,000-ohm potentiometer was used in series with a 62,000-ohm 1-watt resistor to the B-plus potential. This resulted in

giving smooth action. Operation is not at all critical as in other receivers.

**COILS**

The plug-in coils are of the five-prong plug in type. They are five in number and cover the different bands from 15 to 560 meters. Coil-winding data is given at the right of this article.

An earphone jack is provided in order to enable anyone to listen late at night without disturbing the neighbors. When earphones are plugged in the speaker is automatically silenced.

*Bandspread* in a short-wave receiver is extremely necessary if one wishes to hear distant stations. It separates the crowded bands and allows easier tuning.

A .00035 mfd. 3-plate condenser, C-2, which was previously used in an old transmitter, was utilized for this purpose.

The front panel was cut from a piece of plywood and painted. The dial is an old Kurz-Kasch dial and still gives satisfactory service.

**OPERATION**

Operation of this receiver is simple. Plug in the tubes, and a coil, then plug the power cord into the 110-volt AC or DC line. If a pronounced hum is heard, or if the set does not operate, reverse the power plug.

Turn up the regeneration control until a hiss is heard, then turn the knob of the .00014 mfd. tuning condenser until whistles are heard. Then turn back the regeneration control until the station comes in clearly.

**COIL INFORMATION**

	Grid	Turns Per Inch	Tap	Tickler
20 Meters	6 3/4	5	3 1/4 No. 28 enam.	4 3/4 No. 24 enam.
40 "	12 3/4	11	3 1/4 No. 24 enam.	8 3/4 No. 28 enam.
80 "	21 3/4	18	2 3/4 No. 26 enam.	9 3/4 No. 28 enam.
160 "	56 3/4		3 3/4 No. 24 enam.	11 3/4 No. 28 enam.
B.C.	76 3/4	Close wound	7 1/4 No. 30 enam.	14 3/4 No. 30 enam.

Coil form length 2 1/4 inches, diameter 1 1/4 inch.

Tickler coils close wound.

Space between grid and tickler coils 1/2 inch.

Coils wound from right to left. Cathode tap from ground side.

**WIRING UP**

Care should be taken in the wiring. Although the circuit of this receiver is simple, do not hurry, and check each connection carefully. When the wiring is completed, re-check it against the diagram. Number 20 single-strand wire was used in wiring. If several pieces of different colored wire are at hand, use one color for wiring the heater circuit, another color for the plates, etc. This helps to prevent wrong connections. Wiring must be done with a hot, well-tinned soldering iron. Leads should be as short as possible.

**PARTS LIST**

**Resistors**

- R1—1 megohm, 1/4 watt
- R2—25,000 potentiometer
- R3—62,000 ohms, 1/2 watt
- R4—400 ohms, 1/2 watt
- R5—62,000 ohms, 1/2 watt
- R6—150,000 ohms, 1/2 watt
- R7—100,000 ohms, 1/2 watt
- R8—100,000 ohms, 1/2 watt
- R9—1/2 megohm, 1/2 watt
- R10—1500 ohms, 1/2 watt
- R11—500,000 ohms, 1/2 watt
- R12—1/2 megohm, 1/2 watt
- R13—250 ohms, 2 watts

**Condensers**

- C1—.00014 tuning condenser
- C2—.000035 tuning condenser
- C3—.0001 mica condenser
- C4—.00025 mica condenser
- C5—.01 mfd. 400 volt
- C6—.01 mfd. 400 volt
- C7—.01 mfd. 400 volt
- C8—.01 mfd. 400 volt
- C9—.10 mfd. 25 volt
- C10—.1 mfd. 600 volt
- C11—20 mfd. 150 volt
- C12—40 mfd. 150 volt
- C13—8 mfd. 150 volt

**Tubes**

- 1—6F7
- 1—6J7
- 1—37
- 1—25L6
- 1—25Z5
- 1—BM49B

**Miscellaneous**

- 3 octal tube sockets
- 2 5 prong tube sockets
- 1 6 prong tube socket
- 1 7 prong tube socket
- 2 grid caps
- 1 AC-DC filter choke
- 1—5" PM speaker
- 1—earphone jack
- 1—K dial
- 2—knobs
- 1—chassis

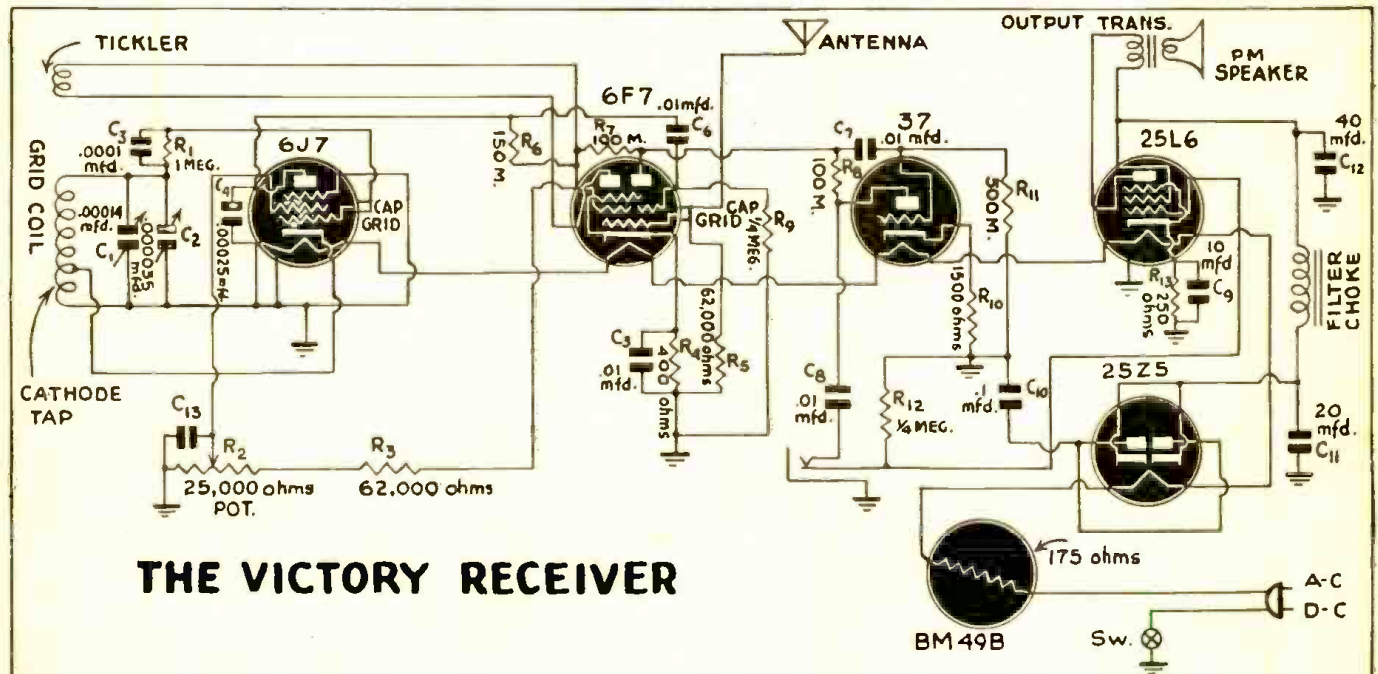

**THE VICTORY RECEIVER**

**YOU CAN BUY RADIO PARTS**

**S**ERVICEMEN and others will be able to buy parts at their usual source of supply (including resistors, condensers, volume controls, receiving tubes, transformers and chokes), even though the new limitations order of the War Production Board on radio parts—Order L-183—recently issued, brings electronic and receiving tube devices under stricter control of the W.P.B. The order generally provides that everything used in the electronic field (from an-

tennae to microphones, from loudspeakers to sockets, either singly or combined into apparatus), is now under W.P.B. control. Order L-44, put into force in the spring of 1942, still stands. (It will be remembered that that order prohibited further manufacture of civilian radio receiving sets.) The new order provides that no one is to manufacture or assemble any electronic devices (which includes receivers, power packs, amplifiers, etc.), in a quantity which

is greater than that needed to make deliveries on orders which have a Priority Rating of A-3 or higher. Inventories must be restricted to a 45-day supply, and in no case to exceed 12.5% of the total sales of 1941.

**PARTS AVAILABLE**

The consumer (radio serviceman or experimenter or home set builder) will not (Continued on page 192)

# •LATEST RADIO APPARATUS.

## NEW OSCILLOSCOPE

Allen B. Du Mont Labs., Inc.  
Passaic, N. J.

**W**ARTIME requirements are responsible for this new cathode-ray oscillograph, offered as a standard instrument, and characterized essentially by a greatly extended frequency range, greater versatility in the handling of applied signals, and special pickup means whereby input capacitance is reduced and stray pickup eliminated. Removable front cover protects panel, controls and tube screen, and also holds the shielded-cable test probe, when instrument is not in use.

One of the outstanding features of this Type 224 unit is the Y-axis or vertical deflection response, which is uniform from 20 c.p.s. to 2 million cycles. It has a comparably faithful square and sinusoidal wave



response. The X-axis or horizontal deflection amplifier has a uniform characteristic from 10 to 100,000 c.p.s. Both horizontal and vertical amplifiers have distortionless input attenuators and gain controls.

The widest variety of signal input connections are available. In addition to the usual amplifier connections, signals can be applied directly to the deflection plates of the 3-inch cathode-ray tube, by means of terminals at the front panel of the unit. The Y-amplifier has an input connection for the shielded-cable test probe Type 242A, supplied with the instrument. This reduces input capacitance and eliminates stray pickup. All high-voltage electrolytic condensers are eliminated from circuit.

The oscillograph weighs 49 lbs.; measures 14 $\frac{1}{2}$ " high, 8 $\frac{3}{8}$ " wide, 15 $\frac{1}{8}$ " deep, and operates on 115 volts, 60 cycles A.C.—*Radio-Craft*

## MICROPHONE SWITCH

American Radio Hardware Co.,  
476 Broadway, N. Y., N. Y.

**T**HIS company announces a new phone-switch, which is ideal for air and ground communications. It is a double-circuit microphone-switch designed for use by an operator wearing heavy mittens and is so constructed as to permit easy "on" and "off" switching. It remains in "open" position normally, but can be locked into the "closed" position if required.

The switch is 4 15/32" overall in length,

x 3/4" thick x 1 1/4" wide. High impact strength Tenite II is used in its construction. The switch is mounted on sturdy brass brackets, with blades made of a phosphor bronze material. It is heavily nickel-plated,

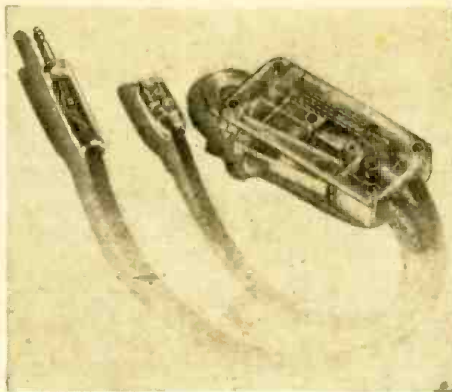

with bakelite insulation. Cordage clamps for taking up cable strain are provided as an integral part of the housing.

Because of its precision construction and unfailing performance, it is used primarily by aircraft radio operators.—*Radio-Craft*.

## FLEXIBLE HEATING ELEMENT

Clarostat Mfg. Co., Inc.  
285-7 North Sixth St., Brooklyn, N. Y.

**A**VAILABLE in any length, by the inch, foot or yard, a low-power flexible heating element now finds many uses, particularly in "tight spots." Known as the Glasohm, and also widely used as a flexible power resistor, it is constructed of resistance wire wound on a fibre-glass core. Overall protection is given by a fibre-glass braided covering. The fibre-glass, while providing the desirable properties of unbreakable and virtually indestructible glass, is almost as

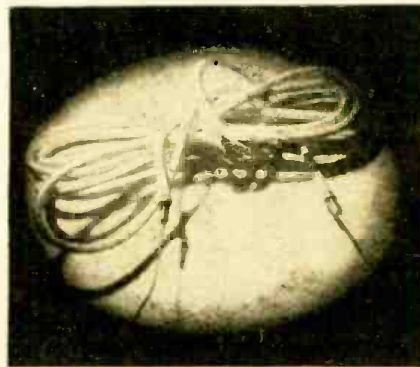

flexible as silk, so the unit can be easily bent and compacted to fit snugly about any parts that are to be heated, or to be jammed into place in a limited area. In either case it provides an efficient heating means.

Typical Glasohm heating elements range from a few inches to several feet in length. They can be made to any required length and provided with any type terminals. Wattage ratings are 1 to 4 watts per body inch, depending on the application. Operating temperatures range up to 750° F.

These heating elements are now used in electric soldering irons, electric pencils, curling irons, water immersion heaters, and other low-power appliances. Also in temperature-controlled ovens for preparing oscillating radio crystals, heating aviation and marine instruments; applying localized heat in chemical apparatus and laboratory equipment; and in similar applications.—*Radio-Craft*.

## FOAMGLAS

Pittsburgh Corning Corporation  
Pittsburgh, Pa.

**M**ADE of glass yet it floats! A spongy-looking, yet hard, workable black substance that is fireproof, waterproof, non-corrosive and durable.

This glass is made by "evolving" internal gas at high temperature. This "cellulates" it, making it look like a bath sponge, only hard and black. It is easily worked—can be cut with a hacksaw, or drilled, or even trimmed with a penknife.

Because it is impervious to water and consists of sealed cells, it is buoyant.

This cellular structure also provides insulation that is highly effective. These two properties suggest application in marine radios or the containing cabinets therefor; or even for apparatus that must be carried across water by men in the field, for dampness or condensation have no effect on it, and vermin can't eat it.

This material is also fire-retardant; it



Foamglas, the new glass product that floats.

simply will not burn. And it will not absorb odors or emit them. Acids have no effect on it.

Those interested in its structural properties will appreciate the fact that this material will support its own weight in any type wall (except bearing walls) without crushing or packing. Its crushing strength is 150 lbs. per sq. in.

It comes in standard piece sizes, packed in cartons.—*Radio-Craft*.

## NEW DUST-TIGHT RELAY

General Electric Co.  
Schenectady, N. Y.

**A** NEW dust-tight relay, primarily designed for aircraft application but also suitable for other work requiring high current-carrying capacity, and compactness and light weight in construction.

The relay is solenoid-operated, with the normally-open contacts rated at 10 amperes direct current. These contacts will make or break 30 amperes at altitudes up to 40,000 feet. The coil, contacts, and plunger are enclosed in a dust-tight housing, and the unit is corrosion-proof, meeting 200-hour salt-spray tests as stipulated by various government agencies.

The relay can be furnished in single-pole, single-circuit form, with normally-open contacts; or in single-pole, two-circuit form, with one normally-open and one normally-closed contact. The operating coil can be furnished for either 12- or 24-volt d-c operation.

Whether the relay is in energized or de-energized state, the contacts will remain in the closed or open position without chattering, even when subjected to mechanical vibrations of 5 to 55 cycles per second at 1/32-inch amplitude (1/16-inch total travel) applied in any direction.

The relay is designed for use in an ambient temperature range of from 203 degrees Fahr. to minus 40 degrees Fahr. and will withstand 95 per cent humidity at 167



degrees Fahr. on 48-hour tests and operate immediately thereafter.

The relay can be mounted in any position on a metallic base.—*Radio-Craft*

**COLOR CODE RESISTOR CARD**

SYLVANIA Electric Products, Inc., announces a color code resistor card for radio technicians, available at your jobber's,

**COLOR CODE CHART—RMA STANDARD**

A		B		C		D	
Black	0	Black	0	Black	0	No Color	±20%
Brown	1	Brown	1	Red	00	Silver	±10%
Red	2	Red	2	Orange	000		
Orange	3	Orange	3	Yellow	0000		
Yellow	4	Yellow	4	Green	00000		
Green	5	Green	5	Blue	000000		
Blue	6	Blue	6	Purple	0000000	Gold	± 5%
Purple	7	Purple	7	Gray	00000000		
Gray	8	Gray	8	White	000000000		
White	9	White	9				

**Resistor Color Code.** The A color of a resistor denotes the first significant figure, the B color the second significant figure and the C color indicates the number of ciphers after the first two significant figures. The D color denotes the tolerance value of the resistor.

**Examples:**  
 Band A (Axial Type) or Body (Radial Type) = Red  
 Band B (Axial Type) or End (Radial Type) = Green  
 Band C (Axial Type) or Dot (Radial Type) = Orange  
 Value of Resistor = 25000 Ohms

Front of Resistor Card

issued at this time as a help in the war-time radio servicing job.

In handy pocket-size form, this card should prove to be a most valuable aid in circuit revision work. It clearly shows the A, B, C and D color denotations of a resistor, explains the resistor color code, and gives examples. On the reverse side of the card is Ohm's Law, and the power formula. Their definition and explanation is a helpful reference for every radio man.

The card has already been welcomed by those who have seen it. Servicemen are

**OHM'S LAW**

When a continuous current is flowing thru a given conductor whose temperature is maintained constant, the ratio of the potential difference or voltage existing between the conductor terminals and the current carried by the conductor is a constant, no matter what the value of the current may be. The mathematical formulas for Ohm's Law may be expressed in the following forms:

$$R = \frac{E}{I} \quad I = \frac{E}{R} \quad E = IR$$

Where E = Voltage in volts.  
 I = current in amperes. R = resistance in ohms.

**POWER**

Power is the time rate of doing work. Since energy is the ability to do work, power may also be defined as the time rate of expending energy. From the fundamental definitions of power, electromotive force and current it is easy to show that power may be computed from the following expression:

$$P = EI$$

Where P = power in watts.  
 E = voltage volts.  
 I = current in amperes.

For your tube requirements use SYLVANIA Radio Tubes.

Back of Resistor Card

running into an increasing number of circuit revisions, and technical helps such as this, give servicemen a lift in the very tough job of keeping America's radio sets working with a limited amount of materials.

**NEW RADIO DEFINITION**

The war has produced many new and picturesque terms and new ones are springing up all the time. One of the latest is the term "Dit-Dah Artist." This is Army slang for a radio operator. Many years ago, it used to be "Sparks." The English at one time—in the old days of wireless—had the term of "Lightning Slinger."

If our readers know of any other new radio Army, Navy or Air Force slang, we will be grateful to them to bring our radio vocabulary up-to-date.



**HERE'S THE ANSWER**

**TO ALMOST ANY CONDENSER REPLACEMENT PROBLEM**

Replacements of dry or wet electrolytic condensers, low voltage or high voltage, single units or dual or triple combinations—Sprague Atom Midget Drys and Type EL Prong-Base Drys handle them all. They take up less space, they cost less, and they're easy to mount. What's more they're *not* substitutes. They're better and more dependable than the old-style large condensers of equal rating that they replace. Your Sprague jobber has them—and you'll find they give you just what you need for 90% or more of the electrolytic replacements you are called upon to make.

SPRAGUE PRODUCTS CO.  
 North Adams, Mass.

Use famous Sprague TC Tubulars for every by-pass condenser need. "Not a failure in a million."

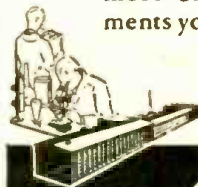

**SPRAGUE**

ATOM MIDGET DRY ELECTROLYTICS • TYPE EL PRONG BASE DRY ELECTROLYTICS

**WESTINGHOUSE ELECTRICAL INSTRUMENTS**

For industrial, central station, laboratory, and general use, portable switchboard and miniature panel instruments are described in a new 34-page booklet announced by Westinghouse Electric and Manufacturing Company.

Somewhat the same in format as the popular and well known quick-selector catalogue, the new publication lists all instrument types for specific applications on an instrument selector chart. Special features, specification data and full-scale range of standard ratings are included.

Design features and physical characteristics of meter pivots, springs, pointers, and cases are described with a note on manufacturing methods. Testing facilities are also included.

Reproduced in the booklet are 120 photographs, 44 representative meter dials and 13 types of strip and circular charts.

A copy of booklet B-3013 may be obtained from department 7-N-20, Westinghouse Electric and Manufacturing Company, East Pittsburgh, Pennsylvania.

**NO BATTERIES FOR PORTABLES**

Owners of portable receivers which operate three ways, on AC, DC and batteries will soon have to do without the batteries. The National Association of Broadcasters last month had this to say on a recent WPB

order on the subject: "Only 35 per cent of the number of batteries produced in 1941 will be manufactured. These will be primarily for radios used on farms. Batteries for the portable type are unobtainable."

# A New Type of Service Manual!

## RADIO CIRCUIT MANUAL -

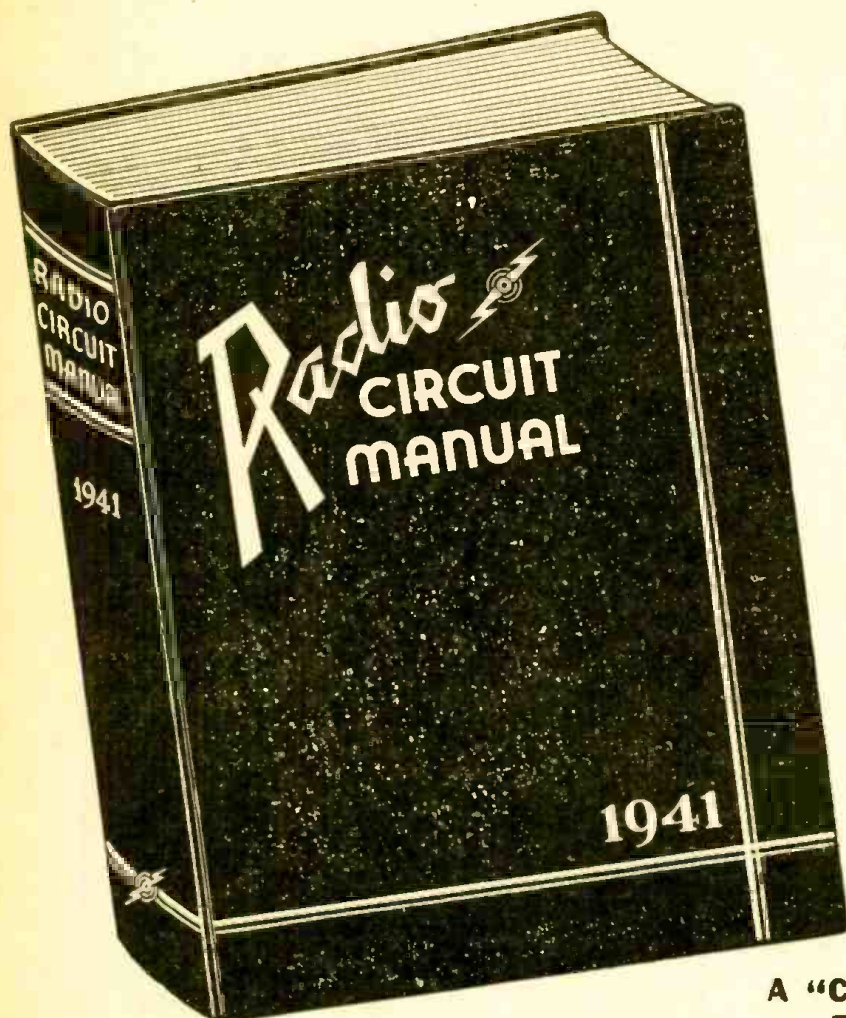

**The Only EDITED Manual  
Ever Published!**

**DIRECTORY OF RECEIVERS MANUFACTURED IN 1940 AND UP TO JUNE, 1941**

**MORE INFORMATION IN HALF THE  
NUMBER OF PAGES**

The value of a service manual is measured not by the number of pages but by the amount of useful information. Thus, in only 736 pages this Radio Circuit Manual covers over 200 receiver models MORE than does any other competitive manual in twice the number of pages.

HOW DID WE DO IT? . . .

. . . . By increasing the size of our page; by discarding non-essential data and editing the balance; by listing only those receivers which the Service Engineer will definitely have to repair (no communications or export receivers, no shortwave sets or amplifiers, no electronic devices, etc.); by many months of hard work based on a definite plan of procedure and a clear understanding of the actual requirements of the Service Engineer. There is no "dead weight" information to add bulk to this Manual. Every word counts. Every minute of reading time is well spent.

### OUTSTANDING FEATURES

- Contains data on more than 1800 receiver models—more than any other radio service manual.
- Only 736 pages—less than half the bulk of any other manual and more than 1/3 lighter.
- All information is EDITED—all non-essential data, deleted and the balance checked and correlated with the schematics and sketches.
- 40% larger page permits listing of all information on one page. (A few unavoidable cases excepted.)
- I.F. peaks for all superhet circuits are boldly displayed in black boxes;—none missing, all accurate.
- No space wasted on communications and export receivers, amplifiers, electronic musical instruments, etc.—a 100% Service Engineer's Manual.

### A "CUSTOM-TAILORED" MANUAL FOR SERVICE ENGINEERS

Here, at last, is a Service Manual deliberately PLANNED for the Service Engineer. Instead of a mere hodge-podge collection of service data, as manuals have been in the past, this RADIO CIRCUIT MANUAL is an orderly compilation of essential radio diagrams and service information, carefully edited and uniformly presented for the maximum convenience of the busy Service Engineer. All time-consuming, non-essential data have been weeded out, and the remaining information, vitally important to the rapid and efficient servicing of modern radio receivers, has been laid out in a logical, easy-reading style which cuts time from the day's work. Because of this and other features which are self-evident upon first observation, it has been possible to list all information pertaining to a given model on a single page.

In 736 pages this Manual presents essential service data on over 1800 receiver models;—more than any other existing service manual on the market!

### ONLY ONE MANUAL PER YEAR!

The new technique used in compiling this RADIO CIRCUIT MANUAL—1941 makes it possible to include in a single book all the new receiver models which the radio industry can produce in a single year. This factor alone represents an important saving to all Service Engineers.



← THE OLD TYPE MANUALS—Bulky, heavy, hard to handle, space consuming, less USEFUL data despite greater number of pages.



OUR NEW MANUAL—Lighter, compact, easy to handle, takes half as much room on the shelf, more USEFUL information despite fewer number of pages. →

### MANUALS NOW READY!

RADCRAFT PUBLICATIONS, INC.,  
25 West Broadway, New York, N. Y.

Gentlemen: Enclosed find my remittance of \$10.00, for which send me, POSTPAID, my copy of the RADIO CIRCUIT MANUAL—1941.

PLEASE PRINT CLEARLY

Name .....

Address .....

City ..... State ..... RC-12-42

(Send remittance in form of check or money order; register your letter if you send cash.)

### ORDER YOUR MANUAL IMMEDIATELY — NOW!

Get your copy directly from us by filling out and mailing the convenient coupon shown at left, or get it directly from your favorite distributor.

736 pages; size 13 1/4 x 10 1/2 x 2 in. thick; loose leaf, leatheroid-covered stiff binder; net weight 6 1/2 lbs.

ONLY  
**1000**

### A PERMANENT INSTITUTION

This Radio Circuit Manual—1941 is NOT a one-time proposition. Next year there will be a Radio Circuit Manual—1942, the following year, 1943 and so on indefinitely—each Manual better than the other as new methods are worked out for expediting and simplifying the work of the practicing Service Engineer.

**RADCRAFT PUBLICATIONS, INC.**  
**25 WEST BROADWAY NEW YORK, N. Y.**

# EASY ONE-TUBER

Here is a real beginner's receiver—one that anyone can build, without having to know anything about either radio or mechanics. Just get a cigar box, a tube and a few other gadgets, and go to it. There's no time like the present!

**A**NY schoolboy can build this unique one-tube set and obtain really good reception at a trifling cost. It is an easy little set to make and will bring in plenty of stations on the headphones.

Apart from its low constructional cost, this set is very cheap to run. It works from a 45 V. "B" battery and takes so little current from the battery that it will last for at least six months and probably longer.

The basis of our one-tube set is the familiar cigar box. Any cigar store will have an empty one to give you—or perhaps your father will hurry up and finish his latest box of cigars, if you will tell him that you are



Fig. A. The complete receiver in the cigar box.

about to build something really useful for once!

One thing about the box; be sure that it is at least 2 in. deep, otherwise it will not hold all the parts. The box contains a tuning coil, a tuning condenser, detector tube and several smaller parts, such as the grid leak, and a small semi-variable condenser for improving the aerial selectivity.

### WIRING DIAGRAM

Perhaps the first thing to study, if you intend to make this set, is the wiring diagram shown in Fig. 1.

The set's main point is the tube which should be a type 30. This tube draws very little current from the plate battery and only .06-amp. from the 2 V. storage cell.

### TUNING THE SET

Tuning is done with a homemade coil, all the dimensions of which are given in Fig. 2. Winding this coil is very easy if you will follow the instructions given in the diagram, anchoring each end of the winding securely and leaving plenty of spare wire for the connections and for the twisted taps. Remember to bare the ends of the tap wires and take care not to cut or break the loops as this would prevent the set from operating.

Concerning the taps; there are two clips making contact with them and you will find that the smallest size "test clips" are fine for this purpose.

What, you may ask, is the object of these

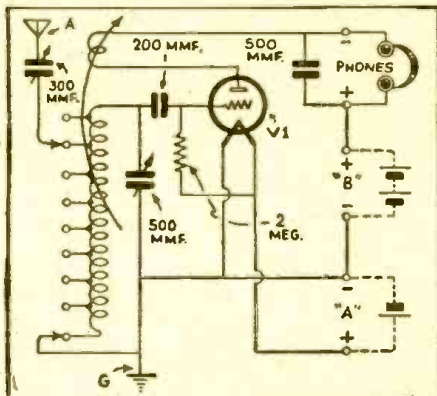

Fig. 1. The wiring diagram of the set—see also Fig. 3.

coil taps? They play an important part in the set's performance. The upper clip shown in Fig. 1 is used for varying the selectivity of the tuning circuit by varying the extent to which the aerial is coupled to the coil. The lower this clip is placed on the coil, the sharper will become the tuning. However, if this is carried too far, the volume of the music will be reduced.

### THE AERIAL CONDENSER

You will note, that a further control of the selectivity may be secured by adjusting the semi-variable condenser which is connected between the aerial lead and the clip just mentioned.

Now for the second clip:—You will find this very useful because it enables you to change the amount of wire across the tuning condenser. This will permit you to tune stations either on high wavelengths or below the usual broadcast wavelengths.

### DETECTOR ACTION

The detector tube follows the tuning coil and condenser. This tube converts the oscillating radio waves into "one-way" pulsations which can effect the phones.

We will not bother with this process just now, but remember that in the plate circuit of the tube there is still radio frequency current flowing, and we make use of this to increase the strength of the music. This radio

frequency current is passed back from the "plate" to the "grid" of the tube, by a process known as regeneration.

### REGENERATION CONTROL

This regeneration is a very important part of the set. Without it, you would not be able to hear the small stations, so take care to make up the small revolving coil mounted on the rod within the larger coil, very carefully. It is this coil that enables the radio frequency current flowing through it to be fed back into the tuning coil.

The regeneration coil (rotating coil) which is fully illustrated in Fig. 2, is arranged to swing inside the tuning coil, at one end, as shown. The degree of feedback or the regeneration is controlled by the position of this swinging coil. You will soon find the position that gives the maximum effect, for at one point the set will produce a squeal, showing that the tube is oscillating.

This oscillating or squealing point is of no use and the object is to reduce the regeneration by slightly swinging back the coil until

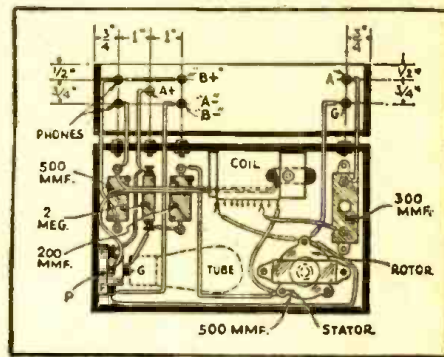

Fig. 3. A suggested arrangement of the parts.

the squeal stops. The most sensitive position of the regeneration coil is just beyond the oscillation point.

Having made up the coil, you should study the diagrams shown in Figs. 1 and 3, to see how the parts are fitted into the cigar box. When they have been mounted, you can then undertake the very simple task of wiring the parts together. Tighten the screws very securely after twisting the wire under the screw head, and it is best to mark each wire on the diagram with a colored pencil as soon as it is inserted so that you will be sure to include all the wires.

### OPERATING THE SET

When the wires have all been tightly fastened in place, you can connect the batteries. The positive terminals in Fig. 1 marked "plus" are often red, while the negative terminals are sometimes indicated with a black color.

The set will work very well on an indoor aerial wire of about 40 ft. but stronger signals will be heard if a longer outdoor aerial is used.

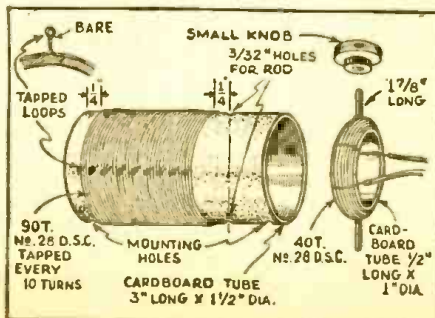

Fig. 2. Instructions for winding the tuning coil and regeneration (tickler) coil.

# HOW TO MAKE A BEGINNER'S ONE-TUBE SHORT-WAVE SET

By FRANCIS R. HARRIS

Nearly every imaginable type of radio "Beginner's" article, except a real beginner's short-wave set, has appeared in past issues of RADIO-CRAFT. In this article Mr. Harris gives complete directions for making a simple but extremely effective one-tube short-wave set that, under good conditions, is capable of amazing results.

**B**ROADCAST wavelengths and the programs they carry are very interesting, but the real thrill of radio lies in the short wavelengths—the higher frequencies—on which it is possible to pick up programs of all kinds from the very ends of the earth!

One or two of our previous Beginner's sets have made provision for reception of the band just below the broadcast spectrum

—down to about 2,500 kc. (120 meters)—but, in general, they have been designed for broadcast reception only. This time, however, we are seriously going after the short waves and build a set that will cover everything from the broadcast down to the beginning of the ultra-short-wave spectrum. Don't get the idea, though, that this means complication and difficulty.

The set we are building this time is the

simplest and the best breadboard style that we have yet constructed. It is designed for the absolute beginner who is neither radio man nor mechanic, and yet it will equal or better the performance of many more elaborate lay-outs.

While we are on the subject of wave bands it might be well to give a list of the principle divisions and their allotted uses; the tabulation gives the frequency in kilocycles (kc.) and the equivalent approximate wavelength in meters.

Usage	Kc.	Meters
Regular Broadcast	550 to 1,500	545 to 200
Short-Wave Broadcast	6,000 to 6,150	50 to 48.7
	9,500 to 9,600	31.5 to 31.2
	9,500 to 9,600	31.5 to 31.2
	11,700 to 11,900	25.6 to 25.2
	15,100 to 15,350	19.8 to 19.6
	17,750 to 17,800	16.9 to 16.8
	21,450 to 21,550	14.0 to 13.9
	25,600 to 26,600	11.7 to 11.2
Police	1,555 to 1,712	193 to 175
	2,412 to 2,508	124 to 119
Aircraft Amateur	2,300 to 3,500	130 to 85.6
Phone	1,800 to 2,000	166 to 150
	3,900 to 4,000	76.8 to 74.9
	14,150 to 14,250	21.2 to 21.1
	28,000 to 28,500	10.7 to 10.5
	56,000 to 60,000	5.3 to 4.9

The set we are building is designed to cover all of these bands from 550 to 18,000 kc. (545 to 16 meters), which should be ample to give a real introduction to the world of short waves; after which—unless we miss our guess—you will be, "rarin' to go," to build a more elaborate layout with greater range.

## CONSTRUCTION

The first step in construction is to get together all the material specified in the List of Parts; the necessary tools; and a fairly large, firm table upon which to work. Tool requirements are simple: a medium- and a small-size screwdriver; a pair of diagonal cutters; a pair of thin, long-nose pliers and a second pair of sturdier construction; a wood saw; a plane; a flat file and a rat-tail file; a hand-drill and a few drills (one No. 18 and one 1/4-in. will be enough to start); a soldering iron (preferably electric) and some resin core solder. Of course, you can use many more tools, if you have them, but those mentioned above will be enough to do the job.

Cut the baseboard to size (its dimensions accommodate all the batteries), clean it up with the plane and sandpaper, and give it a coat of shellac—always put a "Sunday dress" on your work; you've no idea how it adds to your reputation as a radio man among those to whom the technical details are just so many long words; (these folk

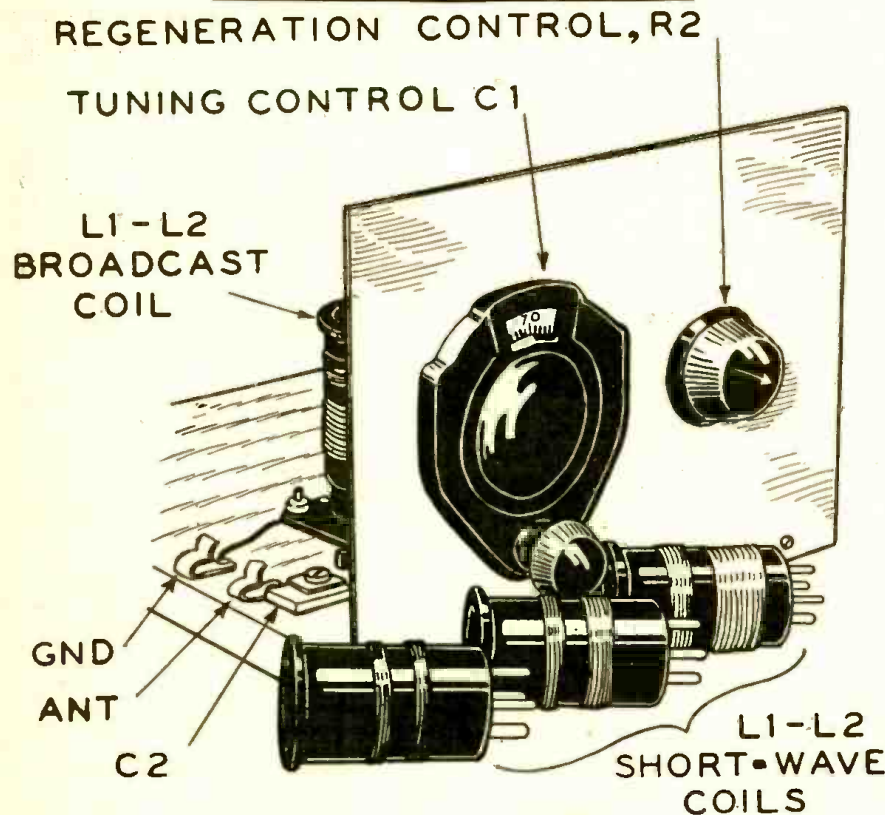

Fig. A  
Front view of the beginner's one-tube short-wave set.

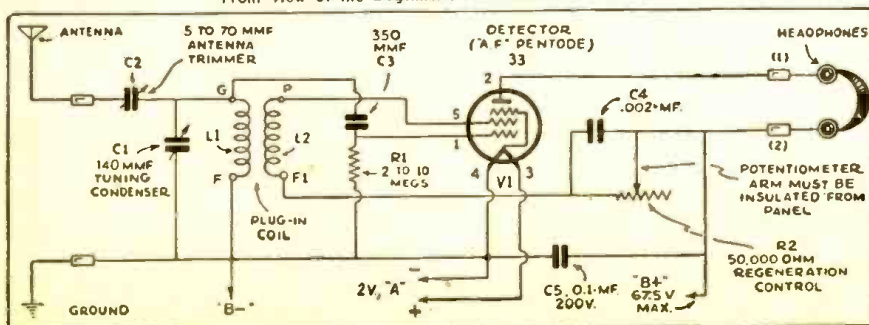

Fig. 1  
The diagram—for those who insist upon schematic circuits.

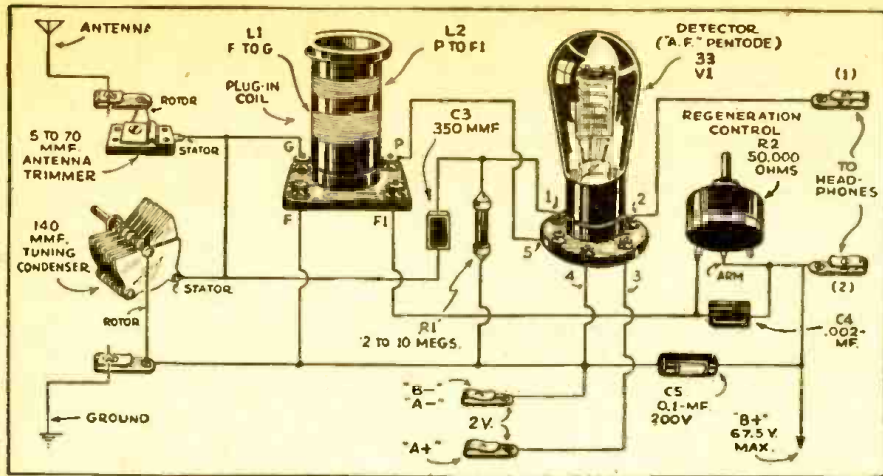

Fig. 2

Don't bother to "read a diagram"—just follow this layout.

usually include the treasury department—in other words, dad).

Cut the aluminum panel to size (if you didn't buy it that way) with the wood saw—it won't hurt the saw. Smooth the edges of the panel with the plane. Next, lay out and drill the three small holes along the bottom for mounting; also the two larger holes for the condenser and potentiometer. If you have a drill of the proper size for these last mentioned holes use it; otherwise, use the largest you have and enlarge the holes with the rat-tail file. Don't scratch the panel all up while working on it as that spoils the whole appearance of the set. Always put a piece of light cardboard between the panel and table top when you hold it down for drilling; and clean away all chips from underneath.

Now fasten the panel to the front of the baseboard and mount all the parts as shown very clearly in the diagram, Fig. 1 and the photographs, Figs. A and B. Then you are ready to wire the set.

WIRING

In wiring, the main point is to be sure of a good, properly soldered joint. (May we remark, "positively." — Technical Editor) Soldering is quite an art, though its requirements are simple. A clean, well-tinned iron and clean surfaces are all the requisites, if the iron is hot. By a hot iron is meant one which causes the solder to flow freely in and through the joint; not one that simply causes the solder to assume a pasty consistency. The proper method to follow in soldering a joint is as follows: first, clean the parts to be joined by scraping them bright; second, make a good mechanical joint (by twisting the parts together, if possible); third, heat the parts with the tip of the iron until solder applied to the parts (not the iron) melts and runs freely. Always use resin core solder, never any kind of acid core, paste or liquid flux of any description.

Referring to Figs. 1 and 2, there may be some question regarding the socket connections of V1. Looking down on the top of the socket, the lone connection is the control-grid, or No. 1 contact in the view and diagram. Continuing clockwise (left to right) around a circle, the connections are, successively, No. 2, plate; No. 3, filament; No. 4, filament; No. 5, screen-grid.

OPERATION

After everything is wired place the tube in the socket, connect the "A," and the negative side of the "B" battery, connect the phones to their clips, and plug in one of the coils.

The filament should show a dull red glow. Now flip the positive "B" wire across its post; if a loud, sharp click is heard in the phones, connect the wire permanently. Connect the antenna and ground wires.

Now, put the phones on your head and turn the screw on the antenna trimming condenser, C2, all the way open; turn the tuning control until the plates of C1 are completely meshed; and adjust potentiometer R2 until all the resistance is out of the circuit—which should be all the way to the right if it is wired in correctly. Touching the stator

(fixed plates) of C1 should result in a decided "thump" in the phones, showing that the circuit is oscillating. As the oscillation control, R2, is turned away from the maximum position this thump will become weaker and weaker, and finally disappear altogether if the entire circuit is in proper adjustment.

Now turn R2 back to maximum and rotate the tuning condenser, C1, slowly to its minimum position, meanwhile touching the finger at intervals to the stator. The thump should be present all the way across the dial.

Repeat the entire sequence given above with each of the coils in turn. If they all oscillate satisfactorily you are ready to adjust the antenna trimmer and start hunting for stations.

Adjusting this trimmer may prove to be a rather tedious process since it is, theoretically, different for each coil. Practically, however, a position is usually found which works fairly well on all coils. To find this position proceed as follows: starting with the broadcast coil in place, check for oscillation as before but on each trip across the dial screw down condenser C2 a little further. A position will finally be found where oscillation stops on certain parts of the band. At this point adjust the screw just a little, until oscillation occurs all across the dial. Then plug in the next smaller coil and repeat the procedure; and so on for all of them. The antenna and ground must be in place for this operation.

TUNING

With any given set there are three main factors which contribute more than anything else to short-wave success: (1) the location; (2) the antenna; and, (3) the tuning procedure. The first, of course, you can't do much about; but the others are within your control.

A word regarding the antenna system may not be amiss here, since the builder of this set is supposed to be an absolute beginner. For best short-wave results the antenna should be as high as possible and strung clear of everything else; particularly, it should be kept away from trees and be well insulated. Two 2 or 3 in., high-grade in-

(Continued on page 176)

VI, TYPE 33 A.F. PENTODE

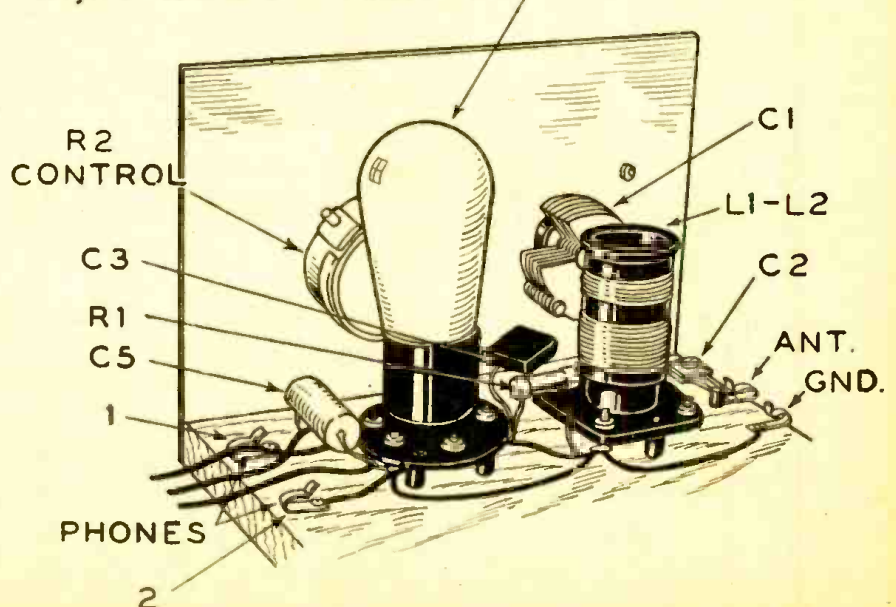

Fig. B

Rear view of set, showing everything but batteries.

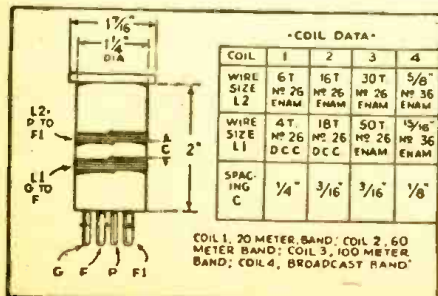

Fig. 3

Complete coil-winding data.

# RADIO SYMBOLS FOR THE BEGINNER

By C. W. PALMER

**T**HE beginner in radio, if he is interested in making headway, tries to learn the symbols of parts used in radio diagrams, and the sooner he learns them the quicker he gets the ideas conveyed in a hook-up.

We believe the chart shown herewith will help the beginner to do this by showing him the most commonly used symbols, both new and old. You must know the old in order to read servicing diagrams of early model radios and power-supply units. We urge very strongly that the beginner also purchase a receiving tube manual, as that gives detailed socket connections for all tubes, and in addition gives a good basic education on receiving tubes, circuits, etc., which help tremendously in solving certain construction or servicing problems which may bother you. In fact it will help you avoid burning out tubes due to wrong connections. And also bear in mind that the manual shows bottom view of socket,—not top. This is very important.

**Aerial:** This symbol represents the ordinary type of outdoor aerial used with most receivers, although it may also be employed to represent indoor or underground aeriels and those with special characteristics such as noise reduction, etc. The loop or coil aerial is shown directly below the extended type. This symbol is used to represent both the flat spiral and the square (box) types ordinarily used.

**Ground:** The standard symbol for a ground connection or "earth," as it is sometimes called, is shown below the aeriels. This symbol indicates connections made to the grounded chassis of a receiver as well as the actual connection to the water pipe or other form of ground.

**Condensers:** Several symbols for condensers of different types are shown. The first represents fixed capacities and pictures of both the mica and the paper insulated varieties are given. The symbol for both is the same. Next is the variable air-insulated condenser of the ordinary rotary type. This is usually represented by two parallel lines with an arrow running diagonally through, but in some cases, the moving or rotating plates are indicated by a curved arrow instead of the flat parallel lines. Below the variable condenser is the "ganged" condenser, which is simply a number of variable air condensers connected on a single shaft for tuning more than one circuit with a single dial. The last condenser symbol is the "condenser block" or group of capacities in a single metal case, which are used primarily for the filter circuits of A.C. power units. The number of individual capacities is shown by the number of small sections in the upper line, and by the number of leads extending from the condenser block.

**Inductors:** The standard symbol for coils of any type is shown first. In this form, the coil is understood to have an air core (no iron or other metal) and may be either a radio frequency tuning coil or an R.F. choke, as the picture shows. When two air-core coils are placed close together, they are coupled and the unit becomes an R.F. coupling coil or transformer, commonly

used for coupling the aerial to the first tube in a set or one R.F. tube to another.

The next in order is the tapped coil. Sometimes it is desirable to change the size of a coil. This is accomplished by bringing leads out from the winding at the desired points; the coil is then said to be "tapped."

Following the tapped coil are several symbols indicating coils with iron cores. The presence of the iron is indicated by the three parallel lines placed either through the spiral (the coil) or adjacent to it. The first is a single iron core coil—commonly known as an A.F. (audio or low frequency) choke coil. We run across this coil in A.F. amplifiers and power units. When two coils are coupled together with an iron core, we have a transformer—either an A.F. coupling transformer, or one used for power supply purposes. A special type of A.F. transformer is shown at the top of the second column; it is the push-pull transformer with a tap at the center of one of the windings, so that two tubes may be connected opposite each other.

**Resistors:** A number of special types of resistors are pictured next. The first is an ordinary fixed resistor of any value; below this is a variable resistor with an arm to make contact at any point on the resistance wire. A special type of variable resistor is the potentiometer or "voltage divider," shown next.

**Circuit Connections:** Wires that cross but are not connected are shown schematically by making a semi-circular bend in one. Wires that cross and are connected together are shown with a black circular intersection—a distinct round dot.

**Crystals:** Two types of crystals are used in radio equipment. First is the crystal rectifier or detector, which is still found in some receivers, although its use has diminished in recent years. This is shown first. Next is shown the piezo-electric crystal, which consists of a specially cut piece of quartz or other special crystal. It is used to keep transmitters in tune and has been used in one special type of receiver to make tuning extremely sharp.

**Switches:** Numerous types of switches are used in radio receivers; some of the most common are the toggle switch, the selector switch, and the knife switch, which may have any number of blades and may have contacts on either one or both sides. The first type, the toggle switch, is shown.

**Fuse:** Two types of fuses are shown: the screw type, such as those used in your house fuse box, and the cartridge type. They are both shown by the same symbol.

**Batteries:** The symbol for a battery consists of alternate long and short lines. The long ones indicate the positive pole and the short ones the negative. Three types of dry cell batteries used in radio receivers are shown—the "A" battery, the "B" battery, and the "C" battery.

**Phonograph pickup:** The popularity of radio amplifiers for phonograph amplification has created a demand for a symbol covering the crystal pickup employed for coupling the phonograph to the radio. This symbol is shown below the batteries. The symbol for the magnetic type

pickup (which occurs in older circuit diagrams) also is shown.

**Loudspeakers:** Both magnetic and dynamic speakers are pictured. The magnetic speaker is shown with its permanent magnet. The field-coil or electromagnet of the dynamic speaker is indicated beside the "voice coil." The difference between the two is obvious from the symbols.

**Microphone:** One of the modern microphones, the velocity type, is shown. The symbol also applies to the ribbon type microphone, which formerly was represented by a coil beside a horseshoe magnet.

**Jacks:** Three types of phone jacks are depicted. The first is the "single circuit type" which merely provides connections for the headphones. The second type is the "double circuit jack" which disconnects the last tube from the circuit when the phones are used in the detector or first stage. (This method of connection was very popular a few years ago.) The last type is the filament-control type that turns off the filament of the power tubes when the phones are inserted in a previous stage. This type was used in many battery type receivers.

**Headphones:** The phone symbol is that which is most generally used. Usually in battery receivers or impedance bridges.

**Terminals:** In the next two sections are shown several devices used to provide connections to parts of the receiver. The first is the "binding post" or terminal which accommodates the end of a wire and connects it to parts of the set. Next we have the phone-tip jack that grips a phone tip and connects it to the output of the set. The third connector is the common power-plug and receptacle found in house wiring.

**Meter:** This is the symbol used to indicate the use of a meter such as a voltmeter, ammeter, milliammeter, etc. The letter indicates the type of the meter.—"A" stands for ammeter, "V" for voltmeter.

**Phototube:** One of the modern light-sensitive (or photo-electric) cells is shown. These are the tubes used in alarms, relay circuits, counters, opacity meters, motion pictures, etc. A separate manual is issued by the tube manufacturers on these phototubes and the beginner would do well to obtain a copy, for phototube circuits are coming to the fore more and more.















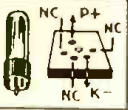

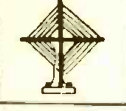







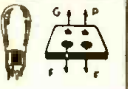

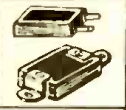



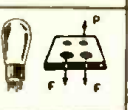



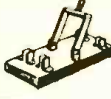

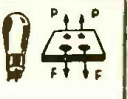

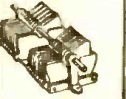



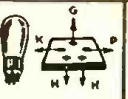





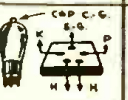











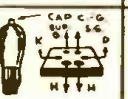





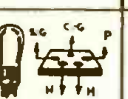





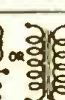

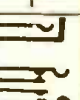
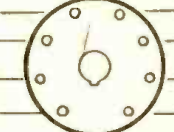

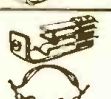









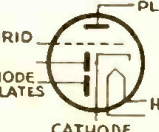

**Vacuum Tubes:** In the first group is shown the more commonly used types of the period from 1922 to 1935. The symbols used are the same that you will find in the circuit diagrams of the time. They are given here principally for reference convenience.

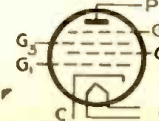
**Octal Base Socket:** This is your standard 8-prong base (bottom view) as used since metal tubes came out about 1935. At one time these numbered prongs were comparable for all tubes; but as new types were developed the connections were changed. That is why we urge you to consult the tube manual. If you guess wrong in hooking up a circuit you may blow out tubes, burn out parts and wind up terribly discouraged.

The typical modern tubes are shown by their present-day symbolism. Two typical tubes are shown—the diode-triode (which

(Continued on page 177)

# Chart of Radio Symbols

	AERIAL			WIRES NOT CONNECTED			PHOTO TUBE	
	LOOP ANTENNA			CRYSTAL DETECTOR PIEZO-ELECTRIC CRYSTAL		<b>VACUUM TUBES</b> 1922 - 1935		
	GROUND			SWITCH (POWER OR FILAMENT-SINGLE-POLE, SINGLE-THROW SW.)			THREE ELEMENT TUBE ("TRIODE")	
	FIXED CONDENSER			SINGLE-POLE MULTI-THROW SWITCH			TWO ELEMENT (DIODE) TUBE RECTIFIER FOR POWER SUPPLY OR DETECTION	
	VARIABLE CONDENSER			DOUBLE-POLE DOUBLE-THROW SWITCH			FULL-WAVE RECTIFIER TUBE	
	TUNING CONDENSERS OPERATED ON ONE SHAFT "GANGED"			FUSE			THREE ELEMENT TUBE, A.C. HEATED CATHODE TYPE ("TRIODE")	
	CONDENSER BLOCK (FILTER OR BYPASS)			BATTERIES			SCREEN GRID TUBE ("TETRODE")	
	R.F. COIL			CRYSTAL PHONO PICKUP			VARIABLE-μ SCREEN GRID TUBE	
	R.F. COILS COUPLED (R.F. TRANSFORMER)			MAGNETIC PHONOGRAPH PICK-UP			R.F. PENTODE TUBE	
	TAPPED R.F. COIL			MAGNETIC SPEAKER			POWER PENTODE TUBE	
	AUDIO FREQUENCY COIL. (MAY BE A.F. CHOKE)			VELOCITY MICROPHONE		<b>OCTAL BASE SOCKET</b> BOTTOM VIEW		
	TRANSFORMER (MAY BE A.F. TRANSFORMER, PWR TRANS. OR FILAMENT TRANS.)			SINGLE CIRCUIT JACK				
	PUSH-PULL AUDIO TRANSFORMER			DOUBLE CIRCUIT JACK		FOR DETAILS OF CONNECTIONS SEE MFRS. TUBE MANUALS <b>NEVER GUESS!</b>		
	FIXED RESISTOR			HEAD PHONES		<b>TYPICAL MODERN TUBES</b>		
	VARIABLE RESISTOR			BINDING POST				
	VOLTAGE DIVIDER (POTENTIOMETER)			TIP JACK				
	LAMP SOCKET PLUG			PLUG RECEPTACLE		DIODE-TRIODE VACUUM TUBE PLATE GRID DIODE PLATES HEATER CATHODE		
	AMMETER			VOLTMETER		MULTI-GRID TUBE THE GRIDS ARE NUMBERED, G <sub>1</sub> USUALLY BEING THAT CLOSEST TO CATHODE		

# FAMOUS 1-TUBE CIRCUITS

Here they are—the foremost old-time diagrams on parade for the radio beginner! Take your choice of circuits that thrilled dad!

**ULTRA-AUDION.** Undoubtedly, the most publicized circuit in radio is the Ultra-Audion—the probable genesis of the regenerative circuit. All-wave operation, from 'way down to approximately 30,000 meters, may be secured using a set of plug-in coils and only one tuning condenser.

**AMBASSADOR.** Without question, the receiver that longest held the spotlight of popular interest was the Ambassador or "3-circuit tuner" receiver. A judicious choice of turns and degree of fixed coupling between coils P and S, and adjustable coupling between T and S, results in any desired degree of selectivity and regeneration control. Winding data: S, about 65 T., No. 20 D.C.C. wire on a tube 3 ins. in dia.; P, about 5 to 15 T., No. 20 D.C.C. wire (same winding direction as S; spacing, about 1/4-in.); T, about 25 T. No. 28 D.C.C. wire of a tube just small enough to rotate inside S.

**INTERFLEX.** Some years ago Hugo Gernsback conceived the idea of confining to a crystal detector the rectification action in a receiving circuit, and using a vacuum tube as an A.F. amplifier—*coupling detector to tube without a transformer.* In this manner considerably greater volume was secured from a 1-tube, non-regenerative receiver. It is particularly important that the "A" and "B" batteries be connected as shown. Incidentally, the Interflex illustrated is ideally suited as a high-fidelity receiver.

**MEGADYNE.** Of special interest to the technician is the Megadyne circuit which utilizes a type 38 R.F. pentode in preference to a triode (the 30, for instance). Note that the use of a crystal detector in the grid circuit of a vacuum tube as used in the original Interflex was retained by Hugo Gernsback in his Megadyne receiver. Follow the schematic circuit *exactly*; the signal is applied to the screen-grid and *not* to the control-grid of the 38. Use only the battery voltage indicated on the schematic circuit. (A grid leak from crystal-grid to filament may improve operation.)

**HARKNESS REFLEX.** When first introduced the Reflex circuit fired the imagination of the more advanced technicians. But it remained for the Harkness Reflex to establish itself as probably the most outstanding of the 1-tube "jobs." The "secret"—if it be such—whereby the Harkness circuit outperformed other 1-tube reflexes is found in the use of two tuned circuits, comprising "antenna" coil L1 and "R.F." coil L2 and respective tuning condensers C1 and C2 (shown ganged for convenience).

**FLEWELLING SUPER-REGENERATIVE.** Some years ago it was demonstrated that amplification considerably beyond that which was ordinarily obtainable from a regenerative tube circuit could be obtained by applying a "suppressor" frequency to a tube circuit that had been permitted to oscillate violently. Termed "super-regeneration," the Flewelling circuit was one of the least complicated. A bank of mica-insulated condensers, C1, C2, and C3, and an adjustable grid-leak, R1, do the trick.

**SOLODYNE.** An importation from England, the Solodyne achieved international prominence as a so-called "batteryless" receiver. However, like the suit of clothes the traveling salesman managed to camouflage into his "swindle sheet," the necessary "B" battery exists in the circuit and is found hiding as part of the "A" supply. Correct balance between control-grid and plate voltages is obtained by adjustment of potentiometer R2. Do not exceed the rated filament voltage of the tube.

**OSCILLODYNE.** Here is another circuit that was the basis of much experimentation. It deserves to be classed among "Famous Circuits." It is a regenerative circuit, unique in that the feedback is very much greater than that required to produce oscillation.

(Continued on page 189)

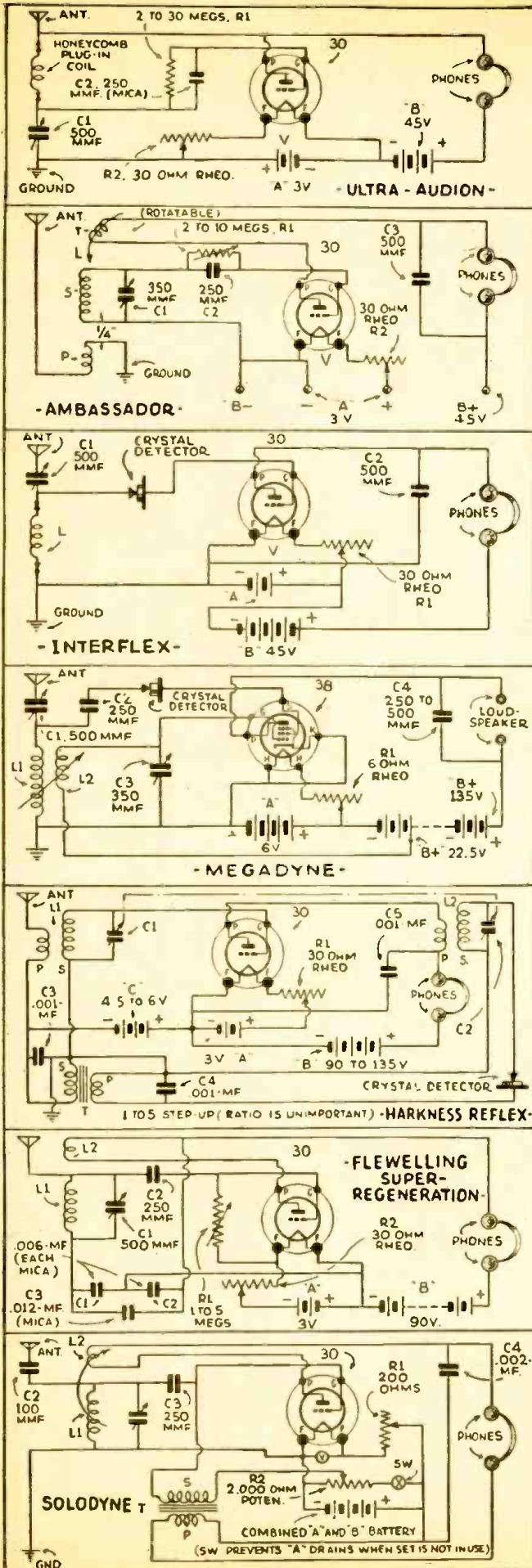



# OFF THE PRESS!

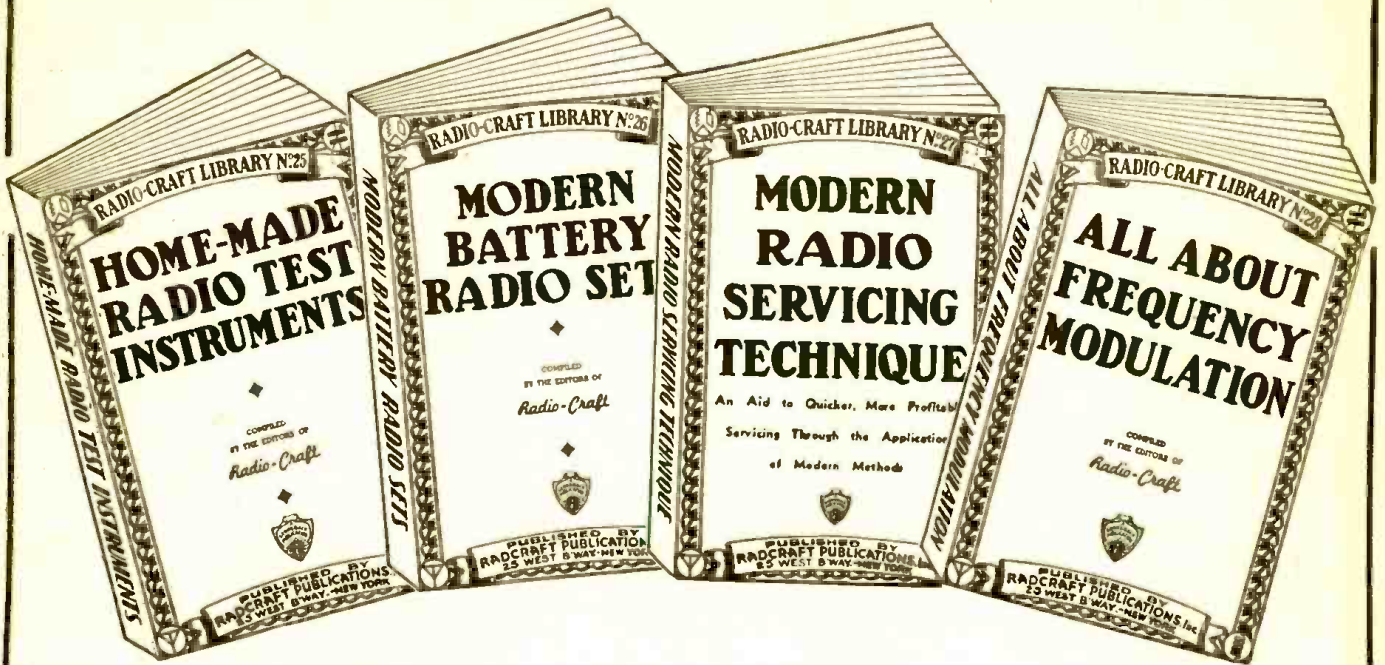

## New RADIO-CRAFT Library Books

**T**HE four latest books of our well-known RADIO-CRAFT Red Books—Nos. 25, 26, 27 and 28—have just come off the press. These four books are all on timely subjects and we recommend every one of them to you strongly.

Now, more than ever, radio education has become a burning question. If you are to be in the National Service, in the Army, Navy or Air Force—practical radio knowledge is of paramount importance. **YOU CAN GET BETTER RATINGS AND ADVANCE QUICKER IF YOU HAVE A GOOD RADIO BACKGROUND.**

Conversely, if you are not with the armed forces, there is a whole of a job to be done at home. With more and more men going into the service, the demand for practical servicemen becomes greater each day. Therefore we say: **PROFIT BY THESE UNIQUE BOOKS, WHICH ARE PRICED SO LOW THAT THEY ARE WITHIN THE REACH OF EVERYONE'S PURSE.**

### No. 25—HOME-MADE RADIO TEST INSTRUMENTS

This book includes articles covering a wide range of test apparatus of live interest to every radio man. Servicemen will find many circuits in this book to make their work more profitable. New ideas in test equipment make it possible to service radio receivers more quickly.

Laboratory workers and experimenters will find many articles which describe in detail construction and use of all essential radio test units—multi-meters, oscillators, stage-analysis testers, oscilloscope equipment, V-T, voltmeters, etc. Even advanced technicians will be interested in the circuit arrangements showing the new and improved variations of well-known, basic test equipment. A MUST for every serviceman. This book contains 86 illustrations.

**Outline of Contents:** A Low-Cost Signal Chaser—Signal Tracer Test Unit—Simplified Practical Signal Tracer—A Home-Made Infinite-Resistance Tube Checker—Build This V-T Voltmeter—How to Make a Modern V-T Voltmeter—Measuring High Values of A.C. Voltage and Current With a Low-Range Meter—How to Make a Meter-Range Extender—How to Build a Practical Tube Tester and Set-Analyzer Adapter—The Beginner's Simple Volt-Milliammeter—Build This Simplified Neon-Type Test Unit—Midjet Oscilloscope—How to Make and Use a Frequency Wobbler—Double Tracing Your Oscilloscope—Home-Made Frequency Modulator.

### No. 26—MODERN BATTERY RADIO SETS

Whether you are a radio man or a beginner, the articles in this book give you basic circuit arrangements or elementary radio receivers which serve the dual role of teaching the elements of radio reception, as well as making perfectly operating 1- and 2-tube radio receivers. Picture diagrams and bread-board layouts follow.

Advanced radio set builders are offered more complicated arrangements. Laboratory workers and engineers will find in many of the articles circuit and constructional features which have become commercial practice. Many entirely new ideas are given in this book. One of the most important volumes we recently issued. This book contains 76 illustrations.

**Outline of Contents:** Beginner's 1-Tube High-Gain All-Wave Receiver—Easily-Built Practical Tracer—A Home-Made Infinite-Resistance Tube Checker—Build This Jewelling Superregenerative 2-In-1 "Card File" Battery Set—A 2-Tube Superhet With Pentagrid Regenerative 2nd-Detector—The 4-Tube Superhet, Vacation Portable—The "Lunchbox 5" Battery Portable—"The Seafarer" Loop-Type Boat Radio Set—4-Tube Permeability Portable—An All-Purpose Portable—A Typical Commercial 3-Way Portable (Pilot Models X-1452 and X-1453)—Switch for Varying "C" Bias on Battery Radio Sets—Making a Simple Portable Aerial—Making a Pilot-Light Fuse—Old Auto Sets for New Cars—Using a Loop Portable in Cars—Quasi-Electric Soldering Iron—Lamp Bulbs as Resistors.

### No. 27—MODERN RADIO SERVICING TECHNIQUE

There is a book of great importance to every radio man, every radio engineer, and particularly all radio servicemen. A list of the contents which follows shows the importance of this book, literally jam-packed to overflowing with radio-meal. Whether you are a servicing beginner or whether you are an experienced serviceman—you will find many important helps in this volume.

This book is eminently practical and will solve many problems for you. More important: It will show you many short-cuts, all calculated to save your time and patience. Practical everyday data on standard receivers appears throughout the book. A whole of a book compressed into a minimum of space. Contains 98 important illustrations.

**Outline of Contents:** Elementary Servicing Technique—Correct Procedure for the Servicing Beginner—Elementary Procedure for Servicing Radio Sets—A.F.C. Alignment Made Easy—Dynamic Servicing—Dynamic Testing Simplified Servicing—Modern Receiver Test Requirements—Servicing Universal A.C.-D.C. Receivers—Servicing "Orphans" and Private-Brand Sets—Emergency Servicing Without Test Meters—Servicing Coils—Servicing R.F. Coils—Servicing Oscillator Coils—General Information—RMA Transformer Color Code—What Causes Echo, Fading?—Radio Service Puzzlers.

### No. 28—ALL ABOUT FREQUENCY MODULATION

Here is a complete compilation of pertinent data on the entire subject of the new coming art of Frequency Modulation.

There is no question but that Frequency Modulation is already revolutionizing radio broadcasting in this country. Were it not for the war, there would now be a tremendous boom in this new art—yet, even with war restrictions imposed upon it, Frequency Modulation is still jumping ahead by leaps and bounds.

With Frequency Modulation no longer a theory—with hundreds of stations already dotting the land and with countless hundreds of others to come when peace is achieved once more—every radio man should read up and know all there is to know on this most important subject.

This particular handbook is chock-full with a tremendous amount of information which you probably will not find in any similar book in print.

**Outline of Contents:** The ABC of F.M.—Frequency Modulation—Amplitude Modulation—Basic Facts About F.M. Broadcasting—Construction—Build This Practical F.M. Adapter—Audio Amplification—F.M. Audio Amplifier, Part 1—F.M. Audio Amplifier, Part 2—F.M. Audio Amplifier, Part 3—F.M. Service—Part 1, Antenna Installation and Service—Part 2, Receiver Alignment and Diagnosis—Part 3, Test Equipment for F.M. Servicing—Engineering—Part 1, The How and Why of F.M.—Part 2, The How and Why of F.M.—Theory and Design Considerations of R.F. and I.F. Coils in F.M. Receivers.

### SPECIAL SEND-NO-MONEY OFFER

It is not necessary that you send money with order. If you wish to take advantage of our C.O.D. plan, simply cut out the coupon, paste it on a post card and send it to us. Books will be sent to you immediately.

All four books are listed uniformly at 50c each. No discount on less than three books.

If you wish to take advantage of our special offer, ordering three books or more, we make an unusual low price to you as follows:

3 books—\$1.25  
4 books—\$1.50

Do not fail to send coupon today!

**RADIO-CRAFT PUBLICATIONS, INC.**  
25 West Broadway, New York, N. Y.

<b>RADIO-CRAFT PUBLICATIONS, INC.</b>	1242
25 West Broadway, New York, N. Y.	
Gentlemen:	
Rush to me by return mail, as per your special offer, the following books: (Check books selected.)	
<input type="checkbox"/> No. 25—HOME-MADE RADIO TEST INSTRUMENTS.	
<input type="checkbox"/> No. 26—MODERN BATTERY RADIO SETS.	
<input type="checkbox"/> No. 27—MODERN RADIO SERVICING TECHNIQUE.	
<input type="checkbox"/> No. 28—ALL ABOUT FREQUENCY MODULATION.	
I will pay postman \$1.00 (if two books are ordered) plus a few cents postage and charges, \$1.25 for three books, plus a few cents postage and charges, \$1.50 for four books, plus a few cents postage and charges. <b>WE CANNOT SEND A SINGLE 50c BOOK C.O.D.</b>	
NAME .....	PLEASE PRINT CLEARLY
ADDRESS .....	
CITY .....	STATE .....
<input type="checkbox"/> Save shipping and C.O.D. charges. Check here if you send cash with order. (Cash, U.S. new postage stamps, money order, check.) Foreign countries no C.O.D. Add 20% to all prices quoted.	

# QUESTION BOX

Edited by FRED SHUNAMAN

## QUERIES

All queries should be accompanied by a fee of 25c to cover research involved. If a schematic or diagram is wanted please send 50c; to cover circuits up to 5 tubes; for 5 to 8 tube circuits, 75c; over 8 tubes, \$1.00.

No picture diagrams can be supplied.

Back issues 1942, 25c each; 1941, 30c each; 1940, 35c each.

Any issue, prior to 1940, if in stock, 50c per copy.

### CONNECTING TUNING INDICATORS

**?** My set uses a 6A7, 6D6, 75 and 42. Please give me a diagram for connecting a "Magic Eye" type tuning indicator.

**A.** The method of connecting the tuning indicator may vary to some extent, depending on the circuit used in your detector. A common method is shown. In sets where the diodes are paralleled, one of them may be used to supply tuning indicator voltage, as shown in Fig. B. In Fig. A, all parts to the left of the broken line are parts of the original set, with the single

exception of the tuning control lead, therefore no values for resistors or condensers are given.

If in any doubt as to the best place to connect the "eye tube" attach its grid through the usual one-megohm resistor to the grid return of the last I.F. tube. The "plus B" lead may be connected to the high-voltage line in the set (200-250v). If not sensitive enough, connect it to the 100v screen-supply lead.

The dotted .05 condenser is to be used if the shadow flutters or if its edges are ill-defined and furry.

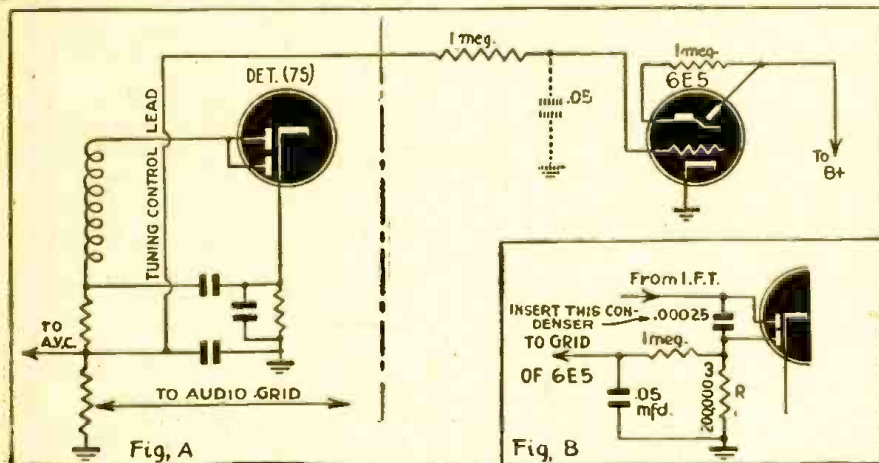

### AN AMPLIFIER FOR PORTABLE RADIOS

**?** Can you supply me with a sketch of an amplifier I can use with my portable, to work off the A.C. line?—R. J., Schenectady, N. Y.

**A.** The diagram shows an amplifier you

can use without making any changes in your present set which would prevent it from being used as a portable. The tubes used are a 35Z4, and 2 35L6's. The insert shows how to connect the single closed-circuit jack, "J", in the voice coil circuit of your

(Continued on following page)

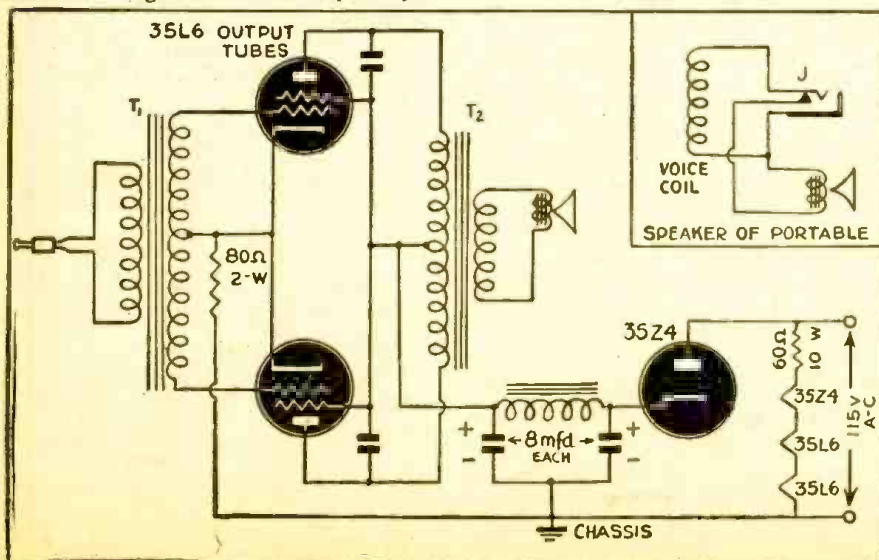

### BEGINNER'S ONE-TUBE SHORT-WAVE SET

(Continued from page 171)

ulators at each end will give excellent results. The best all around wire for antenna purposes is No. 14 solid enamel, about 50 ft. long. The aerial should be pulled taut so that it cannot swing in the wind and thus cause fading. Springs are sold to be placed at the end of aerials for this purpose and their use is advisable.

The lead-in can be made of No. 14 rubber-covered wire securely soldered to the aerial at one end; form a loop so as to allow the aerial to move slightly without eventually causing a break at this joint. Stand-off insulators, holding the wire several inches from the building, should be used at intervals along the length of the lead-in. A lightning arrester on the outside of the building and going to an outside ground is advisable, particularly in rural regions. The lead-in is carried into the house through a porcelain tube which is mounted in the window frame. Slant the tube upward so that it will shed water. Don't under any circumstances, use one of those flat contraptions that is supposed to go under the window.

Inside the house, the set should be grounded with a wire, as short as possible, to the cold water piping. If convenient, this connection should be made on the street side of the water-meter as they sometimes have fiber bushings in them which break the electrical continuity of the pipe. If this is so in your case and you cannot conveniently run the line direct, at least "jump" the meter with a wire securely fastened to each side.

In country districts without piped water an excellent ground can be made to the pump frame, or to one or more pipes driven 5 to 10 ft. into the ground. This may all seem very elaborate, but remember that the finest set made will operate better on an antenna system as described and it will surely operate our little set better. Furthermore, every point noted is important even on broadcast sets and becomes more and more so as the frequency is increased (wavelength reduced).

In locations particularly "tough" for reception it may be necessary to experiment with the direction of the aerial as this sometimes makes an appreciable difference.

The other point within our control, that of tuning, is primarily a question of patience. The most sensitive point for any regenerative receiver is just at the point of circuit oscillation. Turning the tuning dial and oscillation control together, meanwhile checking for the presence of oscillation by the method explained before will give you an approximate idea of just how the two line-up on any given coil. The procedure is to keep the set adjusted just inside the oscillation point and to turn the tuning dial very slowly until you hear a whistle; then, tune for the silent point between two whistles and "juggle" the oscillation control until you bring in the station. For broadcast and phone stations, this will be just outside the oscillation point; and for code stations, just inside. The main points to remember are: slow tuning; and, careful adjustment of the oscillation control.

### TROUBLE SHOOTING

The set is so simple in design that trouble is not likely to occur; the foremost possibility, however, is lack of circuit oscillation. If the circuit will not oscillate, the first thing to do is to reverse the connections to P and F on the coil socket. The grid leak, R1, is also a factor in producing oscillation. Values from 1 to 10 meg. may be tried in

(Continued on page 190)

**QUESTION BOX**

*(Continued from previous page)*

portable so that it can be used either to supply input power for the amplifier or its own speaker. T1 is a transformer of the same voice coil impedance as the output

transformer of the portable. It is used backwards—voice coil to voice coil, and must be a push-pull type. T2 is the output transformer on the speaker. Both output transformer and speaker must be large enough to work suitably with 35L6's.

**POWER PACK**

? Will it be possible to build a power pack to use with my portable? Tubes are 1A5G, 1H5G, 1N5G and 1A7G.—W.R.R., Toronto, Canada, and several readers.

A. As your tubes are all of the 1.4 volt, .05 ampere type, a pack can be built to supply the filaments in series, as per diagram above. It will be necessary to hook the filaments up in series as shown. In some sets it may be necessary to change the grid returns to put proper bias on all grids.

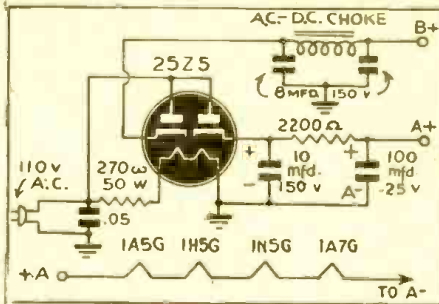

**A 10-12 WATT OUTPUT AMPLIFIER**

? Will you please print a hook-up for an amplifier with 10-12 watts output, using 6F6's in the output stage and with a 6N7 or similar phase inverting tube? The amplifier must have provision for phonograph and crystal-microphone input.

A. Herewith the diagram requested. J1 is the microphone input, J2 for the phono pickup. Any heavy power pack may be used, if it delivers voltages between 250 and 350. The output of this amplifier may be increased up to 20 or 25 watts by substituting 6L6's for the 6F6's in the output stage.

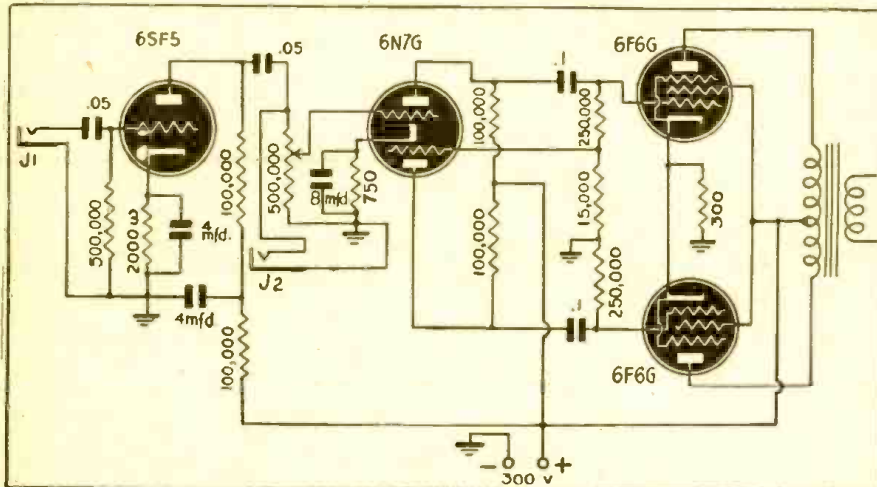

**NOISE SILENCER**

? Please print a hook-up of a simple noise silencer which can be added to a

superheterodyne. The noise is engine ignition.—R. S., Feanek, N. J.

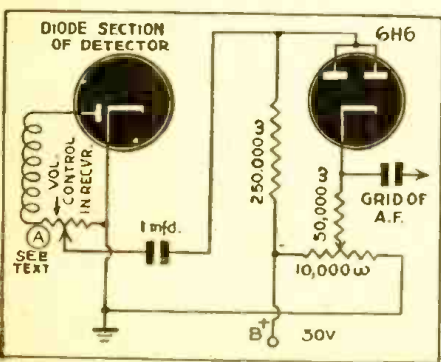

A. The noise silencer shown on the left may be used on any set using diode detection. V1 is the diode section of the detector tube, which may be any of the detector or detector-amplifier tubes. V2 is a 6H6. The 30 volts used by the silencer tube may be obtained by connecting a 25,000 ohm resistor from the 30-volt point to the screen supply, usually about 100 volts.

In sets where there is a path (through resistors) to ground independent of the volume control, the noise silencer diodes may be connected at point "A" instead of to the arm of the volume control, and the volume control put between the silencer and the first audio grid, with an improvement in noise control.

**RADIO SYMBOLS FOR THE BEGINNER**

*(Continued from page 172)*

is commonly used as a detector and first audio-frequency amplifier) and the multi-grid tube (such as the 6A7, 6K7, etc.)

which is used in radio-frequency work. The advice to consult the tube manual for details of connections, applies here also, for although several tubes have the same number of elements they differ in how they connect externally to the circuit of which they are a part.

**UNIVERSITY REFLEX SPEAKERS**  
are the accepted standard of our  
**WAR NEEDS Because**  
Only Reflex Speakers have  
• Super Power Output  
• Long Life  
• Breakdown Proof Diaphragm  
• Waterproof Seal  
These features insure high reproductive efficiency, vital for war work. Only in Reflex Speakers are found years of engineering research work—perfected in your "Speaker" War Programs to our Engineering Staff.  
**UNIVERSITY LABORATORIES**  
225 Varick St., N. Y. C.

**RADIO-TELEVISION INSTITUTE**

Not just another radio school, but a TRAINING ORGANIZATION well equipped with LATEST and MOST EXPENSIVE APPARATUS and staffed by PRACTICAL RADIO ENGINEERS who understand the various branches of RADIO, TELEVISION and the manifold uses of ELECTRONICS.

Our students quickly find profitable positions.

Resident course only. Inquiries invited.

**Radio-Television Institute**  
480 Lexington Ave.  
New York City  
Licensed by the State of New York

**Headset Headquarters**



Our Headphones are used by the United States, Canadian, New Zealand and South African Governments as well as other Governments not directly in the war. Folder C-12 illustrates rugged, unusually sensitive, dependable Cannon-Ball Headsets.  
Write

Scientifically Built Heavy bar magnets greatly increase their efficiency.

**C. F. CANNON COMPANY**  
SPRINGWATER, N. Y.

**Do you need BINDING POSTS ?**



The XL PUSH POST with its Spring Action assures Constant Contact and quick connection. Manufactured in All Aluminum Type M \$1.12c each. Aluminum Body, Bakelite Top Type B1 \$1.14c each. Types CP or NP. ALL BRASS-STAINLESS STEEL SPRING & PIN. PROVEN BY 240 HR. SALT SPRAY TEST as NON-CORROSIVE at 26c each. Manufacturers and Dealers Liberal Discounts

**X. L. RADIO LABORATORIES**  
420 West Chicago Ave., Chicago, Ill.

**USED Correspondence Courses**

Complete Home-Study Courses and educational books slightly used. Sold, rented, exchanged. All subjects. Money-back guarantee. Cash paid for used courses. Full details and illustrated 76-page bargain catalog FREE. Write today! NELSON COMPANY, 500 Sherman, Dept. M-210, Chicago

## DISPOSAL SALE AMPLIFIERS & SPEAKERS

THIS sale comprises amplifiers used in the construction of Juke-Boxes; made by well known manufacturers such as: Rauland and Operadio. All equipment is reconditioned (factory finish) and in perfect mechanical and electrical condition.

THERE ARE ONLY A FEW HUNDRED OF THESE AMPLIFIERS LEFT. WHEN THEY ARE GONE, NO MORE CAN BE HAD AT ANY PRICE, FOR THE DURATION! SEND YOUR ORDERS NOW! COMPLETE SATISFACTION OR MONEY REFUND.

Photo shows 30 watt ampl. #104A



All ampl. shipped Ready to operate

#102A—12 WATT PUSH-PULL 2A3 AMPLIFIER  
Frequency response plus or minus 2DB, from 30 to 15,000 CPS. bass and treble boost. Inputs for phono pick-up or radio tuner. Output impedance 8 or 16 ohms to P.M. or Electro-Dynamic speakers. supplies field current for one or two 2500 ohm speaker fields. An excellent amplifier for FM or recording.

**\$18.45**

Shipping weight 25 lbs.

#103A—20 WATT PUSH-PULL 6L6 AMPLIFIER  
Input for one crystal or dynamic microphone. Input for one crystal or magnetic phono pick-up. Full range tone control. Frequency response 30 to 10,000 CPS. Output impedance 8 or 16 ohms to P.M. or Electro-Dynamic speakers. supplies field current for one or two 2500 ohm speaker fields.

**\$15.95**

Shipping weight 24 lbs.

#104A—30 WATT PUSH-PULL 6L6 AMPLIFIER  
Input for two crystal, dynamic or velocity microphones individually controlled. Input for crystal or high impedance phono pick-up. Full range tone control. Frequency response 30 to 10,000 CPS. Output impedance 2.6, 3.2, 4.5, 8, 8 and 16 ohms to P.M. or Electro-Dynamic speakers. supplies field current for one or two 2500 ohm speaker fields.

**\$21.45**

Shipping Weight 26 lbs.

All Amplifiers Less Tubes & Speakers

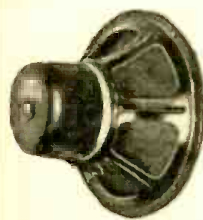

**JENSEN 10 INCH  
ELECTRO-DYNAMIC  
SPEAKER**  
2500 OHM  
FIELD  
16 OHM  
VOICE-COIL

**EACH \$2.95**

Shipping Weight 7 lbs.

ORDERS SHIPPED SAME DAY AS RECEIVED. All goods are sent Express collect if no money for Parcel Post is included in remittance. Customers in Foreign countries are requested to remit in U. S. Currency or International Money Orders and include enough money to ship goods prepaid. Order from this ad.

25% deposit required on all C.O.D. orders.

**PEERLESS RADIO  
AND SOUND CORP.**

11 So. Desplaines St., Dept. 1242 CHICAGO, ILL.

## Diagrams for

# The Radio Experimenter

This is a new department. If you have a new Hook-Up, send it along; a pencil diagram will do. Be sure to include a brief description.

All diagrams and descriptions accepted and published will be awarded a year's subscription. Diagrams may be for receivers, adapters, amplifiers, etc. Send them to Hook-Up Editor, RADIO-CRAFT, 25 W. Broadway, New York City.

### TEN-WATT TWO-TUBE PHONO AMPLIFIER

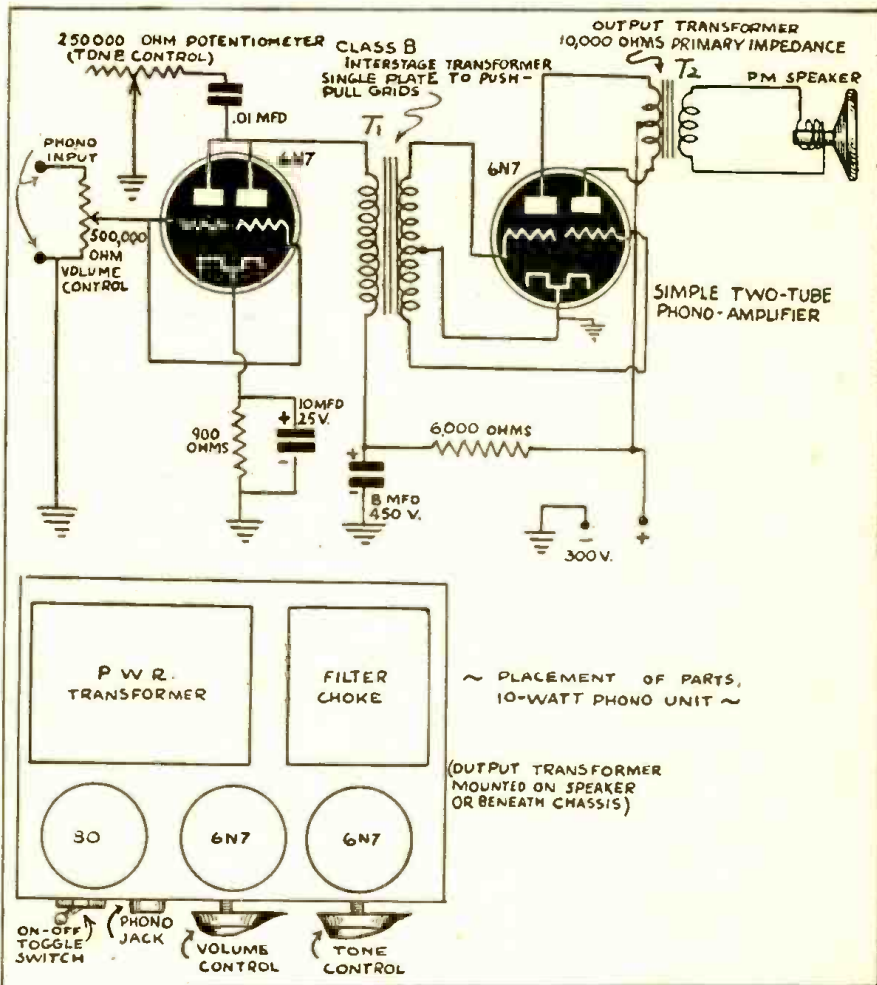

THE two-tube phono amplifier described here is just about the simplest one that will give good results. A parallel 6N7 is transformer coupled to a 6N7 running push-pull. With 300 volts on the plates of the push-pull 6N7 an output of about 10 watts can be expected. This unit is easy to build and easy to make work well, it containing only three condensers and two fixed resistors. Both a volume control and tone control are provided for.

Good fidelity can be had from this amplifier as all the tubes used are triodes.

The output is ample to run a 12-inch permanent-magnet speaker.

As there are no high-gain stages, placement of parts is not critical. For ease of construction, however, we suggest placing the parts as shown in the illustration. A well-filtered power supply should be used with this unit.

FRANKLIN WILLIAMS,  
Glendale, Calif.

### HOME-MADE POWER AMPLIFIER

Here is a diagram of my home-made power amplifier with an audio indicator on it. The potentiometer is not necessary if there is one on the first audio stage. You can use any power amplifier tubes, triode or pentode. You can use types 2E5 if you use 2½ volt tubes and a 6E5 if you use 6.3 volt tubes. This tube is the type used also for tuning eyes in sets. It works very well—

the "eye" will open and close as the audio is increased and decreased. It is very good for comparing signals on the short waves. The receiver can also be put into regeneration when comparing signals. This makes the "eye" more sensitive to the signal.

The tuning eye indicator not only works as indicating audio gain but when listening to two different stations that have different

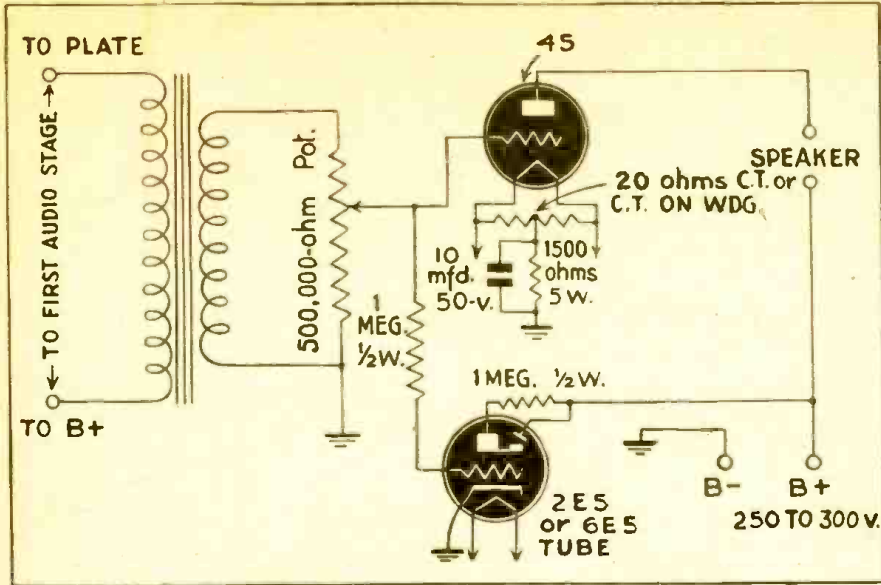

signal strengths it will show the difference on the eye. When listening to C.W. signals, it will wink the code signal to you if you

can read visible signals such as a blinker system.

CLIFFORD PATERN,  
Richmond Hill, L. I., N. Y.

### THREE OSCILLATORS IN ONE

Here is a little hook-up which some of your readers may find interesting. It consists of three oscillators which can be switched in one at a time.

By switching the two toggle switches to the right in the plate circuit and the one in the grid circuit to the left we have an IF osc. The osc. can be bought preferably with adjustable trimmer, or it can be made out of an old IF transformer. A shielded lead is brought out from pin jack (1) to an IF grid lead on a short wave receiver. One loop around the grid lead will provide sufficient coupling. Now beat the

coil. The coil and condenser can be easily obtained off an old battery set. With the B. C. osc. on a phono-pickup can be plugged into pin jacks (1) and records played being picked up on a radio in the near vicinity. The 100,000 ohm var. resistor can now be used for tone control.

If you wish to speak over your radio, just plug a microphone in pin jacks (3) and throw the grid toggle switch to the right (remove phones). The output transformer acts as a mic. transformer feeding back a signal to the control grid thus modulating the B. C. osc. When using a low resistance

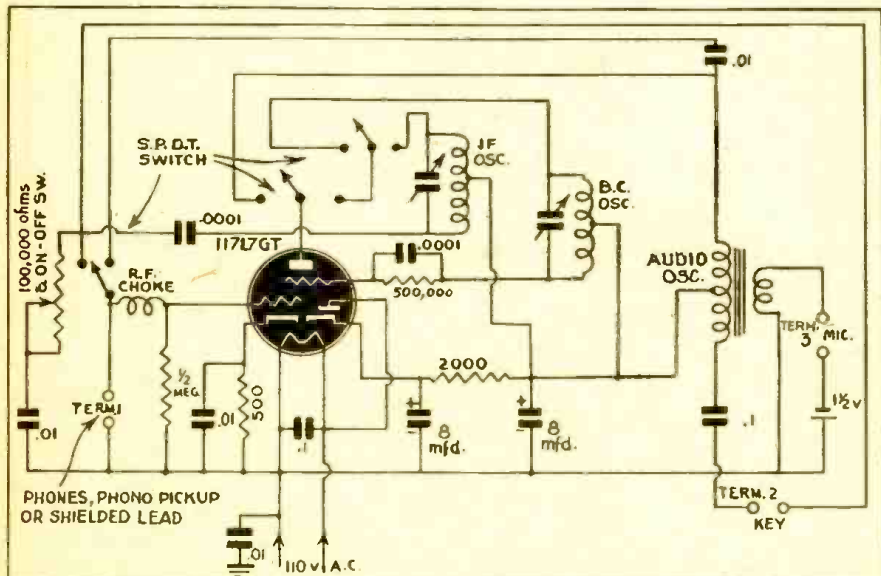

An ingenious oscillator which has many applications.

IF osc. against the receiver IF to bring code out with a clear note. The 100,000 ohm variable should be at minimum to reduce excessive feedback to control grid.

If the upper toggle switch in the plate circuit is thrown to the left, the other two remaining the same, we now have an osc. covering the broadcast band or one end of it according to the number of turns in the

carbon mike it appears to be necessary to use a battery instead of using a dropping resistor and filter condenser to supply mike current.

To practice sending code switch the lower toggle switch in the plate circuit to the left. (This cuts out IF & B. C. osc.) and the grid switch to the left. Now we have an (Continued on following page)

## SPRAYBERRY RADIO TRAINING

includes  
**FULL EQUIPMENT**  
Experience Easily Acquired at Home



You Do Practical - Giving Experiments, Many Special Features... ALL Designed to Help You Make Fast Progress

**SPRAYBERRY FULL RADIO SET**

Training starts right at the beginning of Radio... unfolds each subject in a simplified, logical, understandable style. You easily learn Television, Frequency Modulation, Signal Tracing, Mobile Radio (Auto-Tank), Aviation Radio, Electronics, Facsimile Radio, Radio Set Repair and Installation Work.

Training Prepares You for a Business of Your Own... or Good Radio Jobs—Civilian or Military

The important and fascinating field of Radio offers many opportunities to the man who wants to get ahead. My Training will help you win quick promotion in the Army or Navy... will fit you for a bright Civilian career. SPRAYBERRY Methods are thorough and practical. Your Training will not interfere with your present duties. No previous experience is needed.

You Get a Dual-Purpose Radio Set

I supply you with Radio Parts which you use to gain pre-experience in Repair work. These same Parts are used as a Modern Signal Generator and for Signal Tracing, etc. You'll find my Course and Equipment Fully Described in the catalog offered below.

Earn While You Learn

My BUSINESS BUILDERS show you how to put your equipment to actual use in handling money-making Radio Service Jobs shortly after you begin Training.

THE SPRAYBERRY COURSE IS SOLD UNDER MONEY-BACK AGREEMENT



**RUSH COUPON for BIG FREE BOOK**

**SPRAYBERRY ACADEMY OF RADIO**  
F. L. Sprayberry, President  
320-M University Place, N. W.  
Washington, D. C.

Please rush my FREE copy of "HOW TO MAKE MONEY IN RADIO..."

Name.....  
Address.....  
City..... State.....  
(Mail in envelope or paste on penny postcard)

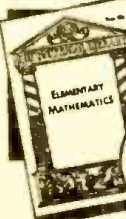

*The Book that takes  
Drudgery out of  
Mathematics*

Only **50c**  
postpaid

**SOLVES EVERYDAY PROBLEMS—HELPS YOU GET AHEAD IN LIFE**

How many times have you lost money because of a mistake in figuring? Do you know how to figure quickly and correctly? Can you figure discounts, interest rates, taxes and all the other calculations you meet up with in your daily life?

Are you having trouble qualifying for Army or Navy promotion because you're not up on mathematics?

Here is the book that gives you a good background in mathematics that takes all the irritation and drudgery out of it. You don't need to be scared of mathematics, because here's the subject explained without frills, without useless computations.

Here's the book for men in the armed forces for business men; technicians and craftsmen, explaining and answering everyday mathematical problems in easy-to-understand words and illustrations.

Yes, it's the key to a simple understanding of mathematics. It's a real home-study course in mathematics for the man who's alert to the importance of mathematics in the world today.

## ELEMENTARY MATHEMATICS

● EASY — SIMPLIFIED — PRACTICAL ●

CONTENTS OF BOOK

- CHAPTER I. Arithmetic—Addition—Subtraction—Multiplication—Division.
- CHAPTER II. Factoring and Cancellation—Fractions—Decimals—Percentage—Ratio and Proportion.
- CHAPTER III. The Metric System.
- CHAPTER IV. How to Measure Surfaces and Capacity (Geometry).
- CHAPTER V. Powers and Involution—Roots and Evolution.
- CHAPTER VI. Mathematics for the Manual and Technical Craftsman—Thermometer conversions—Graphs or Curve Plotting—Logarithms—Use of the Slide Rule.
- CHAPTER VII. Special Mathematics for the Radio Technician.
- CHAPTER VIII. Commercial Calcula. Short Cut Arithmetic.
- CHAPTER IX. Weights and Measures—Useful Tables.

ONLY **50c**  
POSTPAID

Send Stamps, Cash or Money Order.  
Send today for your copy of this indispensable book. It can be carried readily in your pocket. (Size 5 1/2 in.)

## TECHNIFAX

1917 S. State St., RC-1242, Chicago, Ill.

# TECHNICAL BULLETINS

Technical bulletins give reliable information in easy-to-follow form, and save valuable time otherwise spent in laborious reading of numerous books. Every subject is treated briefly and concisely, yet completely. No complicated mathematics, chemistry, electricity, or theory. Each bulletin is written in simple language.

PRICE \$1.00 EACH POSTPAID  
ORDER BY NUMBER

### WELDING, SOLDERING AND BRAZING

**D-105—LATEST GAS-WELDING PRACTICE.**—Contains simplified instructions for using the modern oxyacetylene torch for welding and cutting. Includes instructions for welding steel, cast iron, aluminum and aluminum alloys, lead and lead alloys, nickel and nickel alloys, monel metal, etc. Contains data on lead burning, gas pressure for all jobs, formulas for fluxes.

**D-133—SPOT WELDER FOR THE SMALL SHOP.**—Complete, easy-to-understand directions to build a 110-volt, 50 or 60-cycle A.C. spot welder for fastening light sheet metal. Shows how to make the welder adaptable for operation on 110 or 220-volt, 25-cycle current, or 220-volt, 50 or 60-cycle current.

**D-136—SMALL A.C. ARC WELDER CONSTRUCTION AND USE.**—Tells how to build arc welders capable of fusing iron and steel sheet up to 3/16 inch in thickness and rods as large as 1/4 inch in diameter for use on 110-volt, 60-cycle A.C., 110-volt 25-cycle A.C., or on 220-volt 60 cycle A.C.

**D-135—WELDING SHEET METAL WITH EASILY MADE ELECTRIC ARC TORCH.**—A small carbon-electrode arc torch that operates on 110-volt A.C. current. Of value to metal-working shops and home work shops for soldering and brazing, and even light welding on sheet metal. Can also be used to melt small quantities of metals and alloys. Also used by Dentists to melt gold.

**D-122—WORKING WITH STAINLESS STEEL SOLDERING, BRAZING, AND WELDING.**—Complete practical methods of soldering, brazing and welding stainless steel, including formulas for solders and fluxes and other practical data.

**D-124—SOLDERING ALL METALS, INCLUDING ALUMINUM, AND ALLOYS AND DIE CAST ALLOYS.**—How to produce perfectly soldered joints of neat appearance. Identification of light metal alloys. Solders and soldering fluxes and how to make them. How to make electric soldering irons for light and heavy work, how to construct an alcohol blowpipe.

**D-104—SILVER SOLDERING AND BRAZING.**—Explains practical methods of brazing, silver soldering, and hard soldering. Contains tables giving the composition of brazing and soldering alloys, formulas for fluxes.

**D-141—RECORDING THERMOMETER EASILY MADE.**—Full information on building an accurate device to record temperature changes over 12 hour periods. Uses any type of clock and a sensitive element carrying a pen that marks temperature fluctuations on a Daber chart.

Each Bulletin consists of a set of large sheets, assembled in one pocket, size 9 x 14 1/2"; weight 1/4 lb. Numerous illustrations, diagrams, charts to supplement text.

## TECHNIFAX

1917 S. STATE ST. RC1242 CHICAGO, ILL.

RC1242

**TECHNIFAX** 1917 So. State, Chicago, Ill.

Enclosed find \$..... for which please send me postpaid the following Technical Bulletins:

No. ....

Name .....

Street and Number .....

City and State .....

audio osc. the note of which can be varied by the var. 100,000 ohm resistor. Anybody wanting to add more conveniences might try incorporating a broadcast

receiver or a long wave adapter into the set-up.

E. F. GAULT,  
Saskatoon, Sask., Canada.

### TWO-TUBE SHORTWAVE RECEIVER

This two-tube receiver can be built in three hours and is very easy for the radio experimenter to attempt. The tuning range is 9.5 to 550 meters when used with proper coils. It is not necessary to explain how to hook up the batteries as the diagram is very clear and easy to understand. Conventional

coils are used, preferably of the plug-in type. It will be noticed that only the triode portion of the 1H5G is used, and that an R.F. pentode is used for the amplifier. Unusual—but it works.

GABRIEL LEPAGE,  
Old Town, Me.

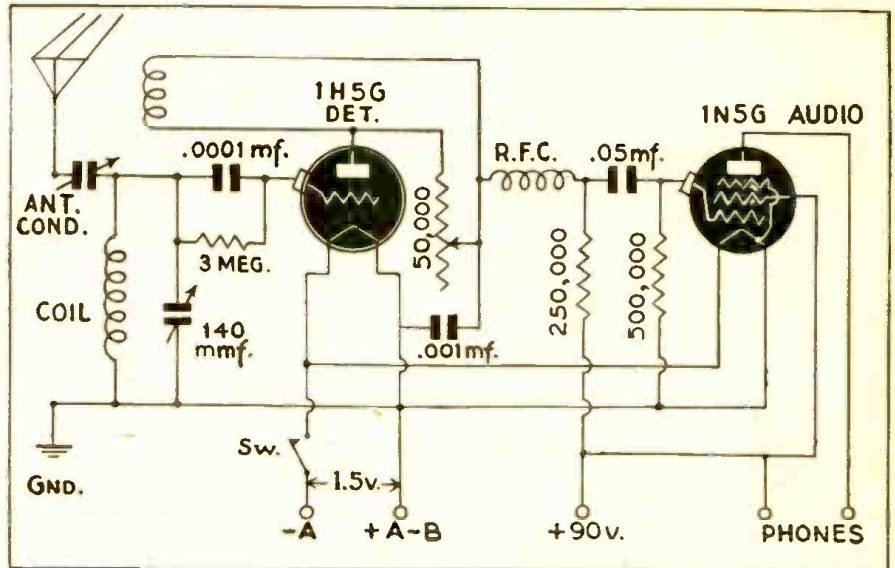

### TINY TWO

Here is a diagram of a small broadcast receiver. Excellent headphone results were obtained with this receiver. It was built on a 3 x 3 inch metal chassis. A broadcast antenna coil was used with 45 turns of litz wire wound around the secondary of the

coil, to obtain the necessary oscillation. The band was clouded with squeals and whistles—and every whistle was a station. A good ground and aerial of 100 feet should be used.

HOMER L. DAVIDSON,  
Fort Dodge, Iowa.

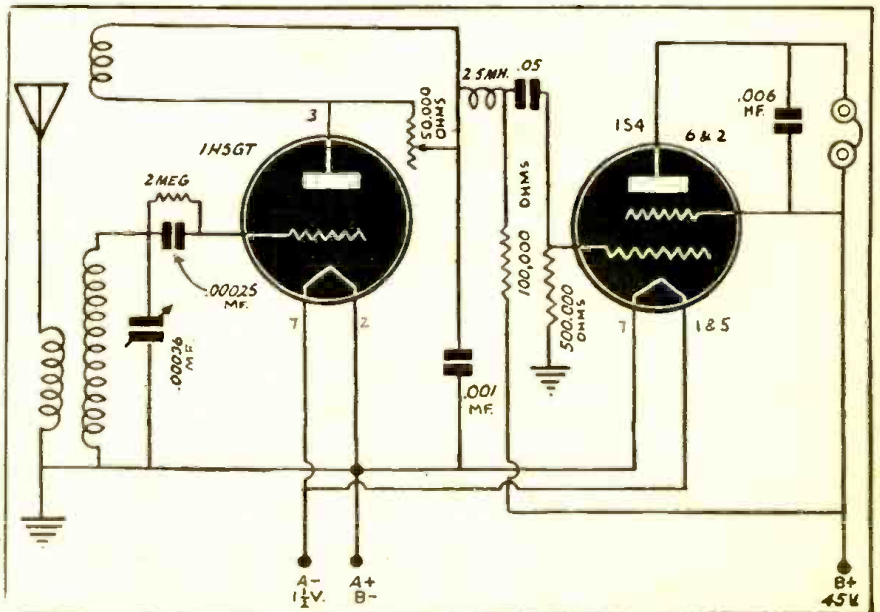

### TEST OSCILLATOR MADE OF JUNK PARTS

In these days when radio parts are expensive and difficult to get, one must conserve and use up what he has on hand.

I am an experimenter and have experimented with everything in radio and I am

still experimenting and trying to improve radio.

Following is a circuit diagram of a test signal generator, which I have designed and built. It's a standard Hartley oscillator.

This generator was entirely made of parts from junked broadcast radios which I took apart. The only parts which were not obtained from the junk box were the battery, tube and chassis.

A broadcast receiver dial may be used, and calibration should be made by coupling the output to the antenna and receiver post

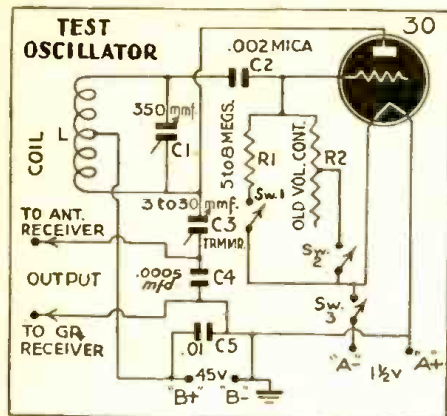

on the broadcast receiver and plot out curves. This generator will give a fundamental frequency of about 500 to 1500 kc, and harmonics from about 1500 kc. to 60,000 kc.

With SW1 and SW3 "on," and SW2 "off," a clear modulated tone will be heard in the receiver. With SW1 "off," and SW2 and SW3 "on," the carrier can be heard on the desired frequency.

**PARTS LIST**

**Condensers**

- C1—350 mfd.
- C2—.002 mf. mica
- C3—3-30 mf. trimmer
- C4—.0005 mf. mica
- C5—.01 mf. tubular

**Resistors**

- R1—5 to 8 megohm resistor, 1/2 or 1 watt
- R2—Volume control from old junk receiver with switch SW2 attached to it. S.P.S.T.

**Miscellaneous**

- SW1—S.P.S.T. switch (also SW2)
- SW3—S.P.S.T. switch
- I—Coils consist of 175 turns No. 26 I.C.C. center tapped at 87 1/2 turns; wound on 1/2" diameter wood dowel jumble wound.

JOE L. DOLHAR,  
Chisholm, Minn.

**CASH FOR OLD RADIO EQUIPMENT**

If you own a communications receiver, or a transmitter, or test equipment, meters and similar apparatus which you are not using, you can help the war effort and yourself at the same time by submitting a list of what you have to Henry Radio Shop, Butler, Missouri, or West Los Angeles, California.

They will make you an offer.

Don't forget that after the war a lot of present stuff will be obsolete and worthless. This way you can get a few dollars that can be used to buy modern equipment later.

**35Z5 BURNOUTS**

To prevent burnout of 35Z5 rectifiers and pilot lamps, place a 300-ohm 1 watt resistor in shunt with single pilot lamp No. 47 or No. 40. If no pilot lamps are used, place an 800-ohm 1-watt resistor in shunt with the tapped section of the 35Z5 filament.

**148 PAGES**  
6 x 9 INCHES  
**OVER 150 RADIO DIAGRAMS**  
**and TECHNICAL PHOTOGRAPHS**  
**RADIO AND TELEVISION**  
25 West Broadway New York, N. Y.

**Your Money Back—**

If the **RADIO AMATEUR COURSE** does not represent the greatest book value ever offered to the radio "fans" for **50c**

To convince you that there isn't a better book buy today, the publishers of the **RADIO AMATEUR COURSE** make the sensational offer of a money-back guarantee on such a low-priced book. Stop in at any of the many dealers handling this book and examine it. See for yourself if the **RADIO AMATEUR COURSE** isn't just the book you've always wanted.

Printed on the finest coated paper—well illustrated attractive 4-color cover—complete with radio information you must have. It contains a step-by-step program for obtaining a short-wave radio education.

Written by **George W. Shuart, W2AMN**  
foremost short-wave authority

**RADIO AND TELEVISION**  
25 West Broadway, New York, N. Y.

Gentlemen: I enclose herewith my remittance of Fifty Cents (50c) for which please send me POSTPAID my copy of the **RADIO AMATEUR COURSE**. (Remit by check or money order; register letter if you send cash or unused U. S. Postage stamps.)  
**PLEASE PRINT CLEARLY**

Name .....

Address .....

City ..... State ..... RC-12-42

Order your copy **NOW**—the only

# P. A. HANDBOOK

Only 25 Cents a Copy

THAT no book has yet been published which covers amplifiers and sound systems (also kindred systems), in one complete, authentic volume is almost unbelievable. Yet, it is a fact, there is no book in print which covers Public Address from A to Z.

**A MATCHLESS VOLUME**

As complete as you would expect to find any engineering handbook—this is how the radio or P. A. man finds the **AMPLIFIER HANDBOOK AND PUBLIC ADDRESS GUIDE**. With essential technical data compiled from an exceptionally large number of sources, the volume covers nearly a hundred different subjects coordinating every conceivable branch or sub-division of Public Address.

**RADIOCRAFT PUBLICATIONS, INC.** RC-12-42  
25 WEST BROADWAY, NEW YORK, N. Y.

Gentlemen: Enclosed and my remittance of 25c for which send me **POSTPAID** one copy of your **NEW 1940 AMPLIFIER HANDBOOK AND PUBLIC ADDRESS GUIDE**. Send me ..... others for friends, also **POSTPAID @ 25c each. PLEASE PRINT CLEARLY.**

Name .....

City ..... State .....

Remit by check or money order; register letter if you send cash or unused U.S. Postage Stamps.

**Ip** Are you interested in **SOUND MOTION PICTURE PROJECTION?**

**SUBSCRIBE TO INTERNATIONAL PROJECTIONIST**, the only magazine published that is devoted exclusively to the mechanical and electrical principles of professional sound motion picture projection. It deals with the arc lamp, film projector, sound track, photoelectric cell, sound amplifier, maintenance and repair of projection equipment, and with every detail of high-calibre, professional motion picture projection. I. P. has the endorsement of leading projection supervisors of the United States and Canada.

**INTERNATIONAL PROJECTIONIST**  
19 West 44th St., N. Y. C.

Enter my subscription for

1 Year—12 Issues—\$2  
 2 Years—24 Issues—\$3  
(Foreign—50c per year extra)

Name .....

Address .....

# THE ELECTRO-SET



Get This Electro-Set  
**ABSOLUTELY FREE!**

JUST THINK OF IT—you can get absolutely FREE the static electrical set described below. This ELECTRO-SET is sent to you by the publishers with a one-year subscription to RADIO-CRAFT.

AN IDEAL  
PRESENT FOR  
BOYS and GIRLS

Here is the ELECTRO-SET. It will throw bright electric sparks up to 1/2 in. long. A lot of fun for all—educational and instructive, too. **YET ABSOLUTELY HARMLESS.**

HERE is the newest and most simple electrical generator that has ever been devised. By using an entirely new substance, static electricity can now be generated by any child or grown-up. The ELECTRO-SET gives not only strong, bright electric sparks, but you can perform dozens of fascinating experiments with it, such as you have never thought possible before.

The ELECTRO-SET uses no batteries and it is not plugged into the electric light-line. It is completely harmless and cannot hurt you, yet delivers long and tinkling electric sparks.

Lots of fun for parties. You can also give your friends a lot of surprises by shocking them with harmless electric shocks produced by the ELECTRO-SET. The operation is simplicity itself and here is nothing else to buy.

THE OUTFIT COMES QUITE COMPLETE. Here is how it works:



Raise your friends' hair with the ELECTRO-SET.

Place the special Electrodyne sheet on any mottled surface such as a tin plate, metal desk, etc. Attach the Electrodyne sheet loosely with the special "RUBBER" that comes with the outfit. Now place the round disc-electrode, with its insulating handle, on top of the Electrodyne sheet. Then when you lift the disc up, it is electrically charged and you can draw long sparks from it. This can be repeated dozens of times without further rubbing, because the powerful Electrodyne sheet will hold the electrical charge for days, and often weeks.

We have shown a few exciting experiments of more than 100 which you can perform with the ELECTRO-SET. You can make your friends' hair stand up. Then you can perform a really marvelous and exciting Salt-storm which actually is a miniature snowstorm.

You can mystify your friends with the Electric Spider Web which gives a remarkable sensation of LIVE SPIDER WEBS tingling all over your face. Then you can demonstrate the Crazy Electric Balls.

Did you know that you can SMELL ELECTRICITY? You can with the ELECTRO-SET. You can HEAR ELECTRICITY with the ELECTRO-SET. You can FEEL ELECTRICITY with the ELECTRO-SET. You can TASTE ELECTRICITY with the ELECTRO-SET.



The amazing Spider Web—one of the most mysterious electrical effects ever produced—yet completely harmless.

TRICITY with the ELECTRO-SET too!

There is no end of fun that you can have with your ELECTRO-SET. You can make numerous experiments yourself besides the many listed in the full set of instructions.

**MOST IMPORTANT.** There is positively nothing to wear out with the ELECTRO-SET. With ordinary care the ELECTRO-SET'S parts will last for years.

You do not have to build anything to make all of these experiments, because the ELECTRO-SET comes to you COMPLETE. Within two minutes after you have received it, you are able to perform the experiments shown here, as well as many others listed in the instructions.

Send your subscription to RADIO-CRAFT for One Year (12 issues) and receive absolutely FREE one of these remarkable sets. New subscribers are needed or you may extend your present subscription another twelve months. Mail your remittance of \$2.00 to the publishers, (Canada and foreign \$2.75.) You will receive your ELECTRO-SET immediately by return mail.

**RADIO-CRAFT**  
25 W. 87th St., N. Y.

**RADIO-CRAFT, 25 W. BROADWAY, New York, N. Y.**  
Gentlemen: Enclosed find my remittance of \$2.00 for which enter my subscription to RADIO-CRAFT for one year (12 issues). Send me immediately FREE and prepaid the ELECTRO-SET (Canada and foreign \$2.75).  
 New Subscriber  Extend Present Subscription  
Name \_\_\_\_\_  
Address \_\_\_\_\_  
City \_\_\_\_\_ State \_\_\_\_\_  
(Send remittance by check, money order or unused U. S. Postage Stamps. Register letter if you send cash or stamps.) **RC-12-42**



The great Electric Salt-Storm. One of the prettiest experiments to watch. It really is a miniature snowstorm!

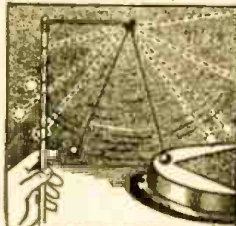

The Crazy Electric Balls. Watch the performance of these erratic and funny balls. They do the most unexpected things.

## SIMPLE PHONO-OSCILLATOR

The diagram shown below shows a simple phono-oscillator. Except for the switch, wiring and chassis, only four parts are needed—a tube socket, one tube, a tuning condenser and a coil.

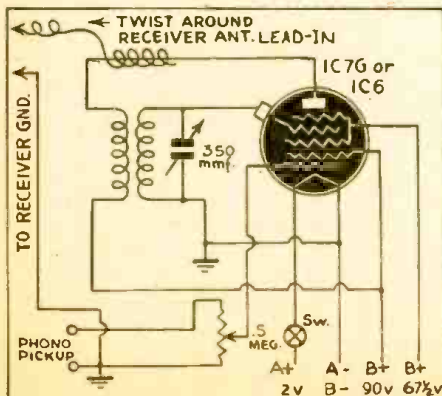

The coil may be handwound, or an oscillator coil taken from an old superheterodyne receiver may be used.

The condenser used is a padding condenser of 350 mmf. capacity or thereabout, and is tuned with a screwdriver.

Any of the battery type pentagrid converter tubes may be used. For use with a 1.4 volt "A" supply, use a 1A7G tube and use 90-volts on the screen grid.

The output is taken from the plate of the tube by means of a wire which is given a few turns around the receiver lead-in wire, the other end being twisted around the plate to coil hook-up wire.

Insulated wire is used and no direct connection is made with the plate of the oscillator tube.

When used with sensitive receivers it will not be necessary to couple the oscillator to the receiver with a wire, owing to the greater pickup.

HADLEY M. HOPPER,  
Herrick, Illinois.

## BRIGHTER LIGHT

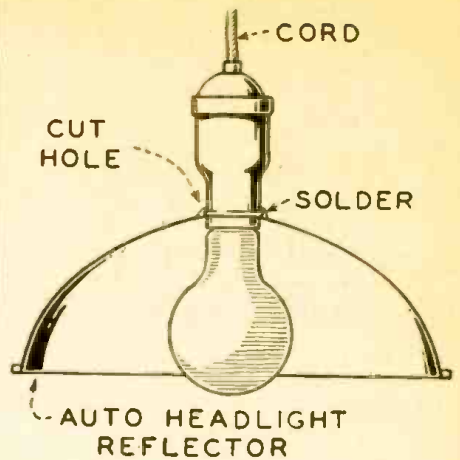

The above is especially good for the work bench or operating table because it throws a bright spot on the table and increases the intensity of the lamp used three times. The higher the lamp is from the table, the greater the diameter of the reflector should be.

BOB STOFAN, W2SWL,  
Teaneck, N. J.

## CODE PRACTICE SET

I designed this set myself and find that it works very well. This set works on a

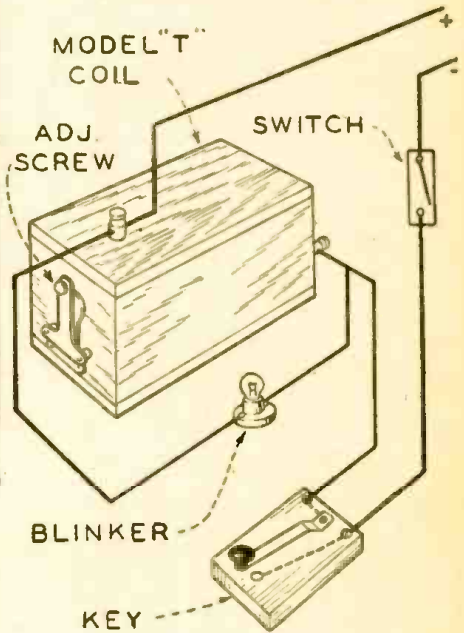

storage battery or dry cells. It is not operative on direct current.

VICTOR SHAMP (Age 14),  
Ionia, Mich.

## REGENERATIVE SET MAKES CODE-PRACTICE OSCILLATOR

Here is a simple method of converting a regenerative receiver into a code-practice oscillator. All that is necessary is an audio transformer. All four leads from the transformer should be connected to pins of an old tube base, as shown in the diagram. When oscillator operation is desired, simply remove the plug-in-coil from the receiver,



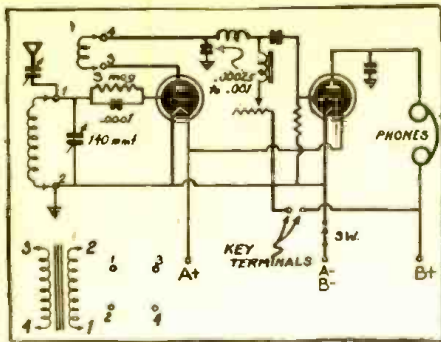

one is used, and the regeneration control. The ordinary two-tube receiver used this way with 45 or 90 volts on the plates will develop enough output to operate a small speaker. So far this method is original with me.

LIONEL GAYLE,  
Kingston, Jam., B.W.I.

**VOLT-OHM METER**

Here is a very useful volt-ohm meter used for radio testing. It is an excellent 500 volts D.C. and is useful for testing Weston voltmeter. The numbers may be volt tester as it will read potentials up to

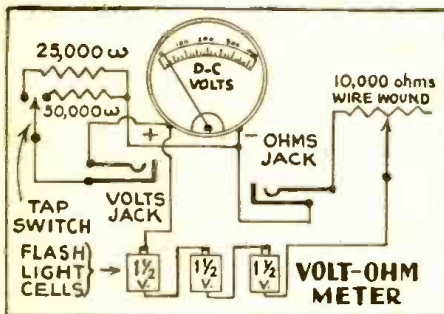

circuits. The type of meter used was a 0-5 changed so that it will read 0-500 volts D.C. A brown bakelite panel will make it look very attractive.

STUART JASPER,  
Chicago, Ill.

**STARTING SMALL MOTORS**

Usually motors of one-quarter to one-half horsepower are too small to warrant a starting box. However, throwing these motors directly across the line, especially if under load, may very often blow fuses due

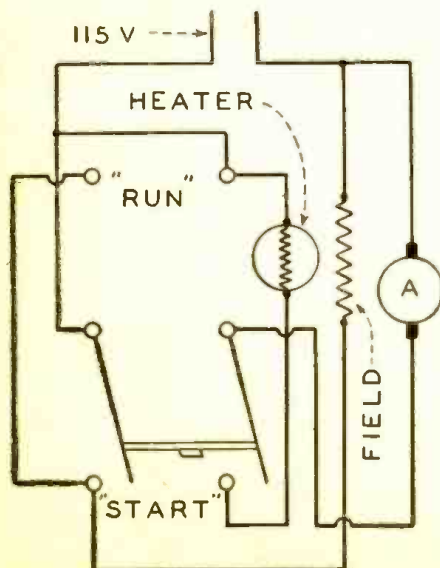

and plug in the transformer inserting the key in the detector B+ lead, or in series with the earphones. If oscillation is not obtained reverse either the primary or secondary leads (not both) of the transformer. The pitch can be varied by means of the tuning and aerial condensers, the filament rheostat, if

**TONE CONTROL**

Herewith is a diagram of a tone control which may not be original, but which I have not seen in any radio magazine. It gives all the benefits of an electronic tone control without the expense of a tube or choke and the many other components. It is very easy to build, and I believe that most fellows will have the parts in their junk box. I have designed it to go in the grid circuit of the pre-amplifiers. It will not work in the

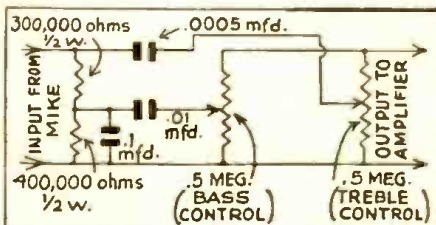

output of any power tube. The ideal setup is to connect the mike or pickup to the control and the output to the amplifier.

P. FISK,  
Montreal, P. Q., Canada.

**PROTECTING THE VOICE AND EARS OF OUR FIGHTING FORCES**

Lives—Victories—depend on the proper performance of the radio equipment which is the voice and ears of our fighting forces. Army and Navy technicians depend on the same accuracy, dependability and ease of operation which have made the name Supreme famous for over 14 years.

Supreme Radio Testing Instruments keep communications open.



**SUPREME** GREENWOOD, MISSISSIPPI U. S. A.  
TESTING INSTRUMENTS

**Speed up REPAIR JOBS**

With These Handy **GC**

**SERVICE AIDS**

**New Instant Automatic Wire Stripper**

Strips all types of wire instantly, easily and perfectly. Just press the handles. Cuts wire too. Saves time, money and trouble for Radio Men, Electricians, Sound Men, etc. List price \$6.00.



**Ne-O-Lite Electric Trouble Shooter**

Every Radio Man and Electrician should have one. Tests AC and DC lines. DC polarity, blown fuses, etc. Traces ground line in AC circuits. Useful as RF indicator, spark plug and cable tester. Has hundreds of other useful applications. Can be used on 60 volts AC to 500 volts AC or DC. List price \$1.00.

**Radio Chemical Laboratory**



20 large 2 oz. bottles contain cements, solvents, contact cleaners, non-slip dial chemicals, lubricants, ins. varnish, cabinet stains, glue, coil dopes, etc. Dealer net cost \$4.90 with FREE RACK.

ORDER FROM YOUR RADIO JOBBER

**GENERAL CEMENT MFG. CO.**  
Rockford, Illinois, U.S.A.

**MIRROR**

**RECORD DISCS—NEEDLES AND ALL EQUIPMENT**

**FOR INSTANTANEOUS RECORDING**

We specialize in the manufacture and sale of Blank Recording discs for all purposes. Our famous Gold Label DISCS are used extensively by Broadening and Professional recording studios. Our Semi-Professional "Pronto" Recording DISCS are just what the student and Home Recording enthusiast needs.

BOTH type discs cost about half of other professional types, because they use "NITRATE cellulose," instead of unobtainable aluminum or fragile glass.

Write for our price sheet

**MIRROR RECORD CORP.**

58 WEST 25th ST., N. Y. C.

# LEARN! . . .

## CODE

By copying code with an

# Echophone

## COMMUNICATIONS RECEIVER



MODEL EC-2

Here's the new and improved version of this popular set. Now with an external speaker (just like EC-3). Automatic noise limiter, preselection on all bands, calibrated handspread, AC-DC, safety headphone jack, 8 tubes, 550 Kc to 30.5 Mc. Bigger value than ever at only \$42.50, complete with speaker in matching cabinet.

## THEORY

From These Radio Books, For The BEGINNER to the ENGINEER

FUNDAMENTALS OF RADIO Everitt, Smoby, etc.	\$5.00
RADIO OPERATING QUESTIONS & ANSWERS Nilson & Hornung	2.50
PRACTICAL RADIO COMMUNICATION Nilson & Hornung	5.00
RADIO CODE MANUAL Nilson	2.00
RADIO ENGINEERING HANDBOOK Keith Henny	5.00
RADIO ENGINEERING F. E. Terman	5.50
RADIO PHYSICS COURSE Ghirardi	5.00
MODERN RADIO SERVICING Ghirardi	5.00
A.C. CALCULATION CHARTS Lorenzen	7.50
VACUUM TUBE VOLTMETERS Rider	2.00
THE CATHODE-RAY TUBE AT WORK Rider	3.00
UNDERSTANDING RADIO Watson, Welch, Eby	2.80
INDUCTANCE AUTHORITY Edward M. Shlepe	2.50

Mail in your order today!

# HARRISON

RADIO CORPORATION

11 WEST BROADWAY

NEW YORK CITY

### CIGAR BOX TUBE TABULAR

Some experimenters and servicemen have a great deal of trouble in locating their tabular cards which come with their tube testers. I have built a "Cigar Box Tube Tabular" which saves time in locating the tube number, filament voltage, characteristics, and plate voltage. I secured a cigar box and cut a small window in the top and covered it with cellophane to prevent dust from getting on the tape.

The rollers for the tape were made from a miniature broom about a half-inch in

diameter and five and one-half inches long, with two small cranks for turning. By turning the cranks and looking into the window, each tube may be classified separately and clearly. I typed (double-spaced) all information concerning each tube on the tape (paper). Just above the window on the front is located the classification of each tube as it appears in the window.

ALVIN J. SHOWERS,  
Mobile, Alabama.

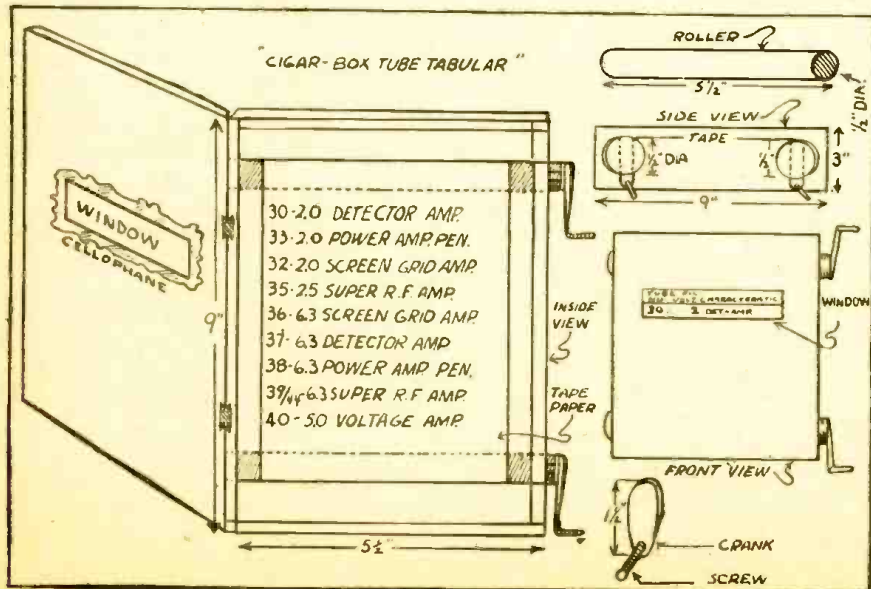

### AERIAL TUNING ARRANGEMENT

Following is a sketch of an aerial tuning arrangement I have been using for some time and find it very good. I thought perhaps other readers of your fine magazine might like to try it.

All the coils can be wound on 1/4-inch diameter forms, or the short-wave coils can be wound self supporting as shown. Both work equally well. Be sure the link coil is wound on the antenna end of the tuning coil. Do not ground antenna coil, but ground one side of the link coil as shown. Hook up as per dotted lines if doublet antenna is used and if receiver is provided with doublet terminals. In this case

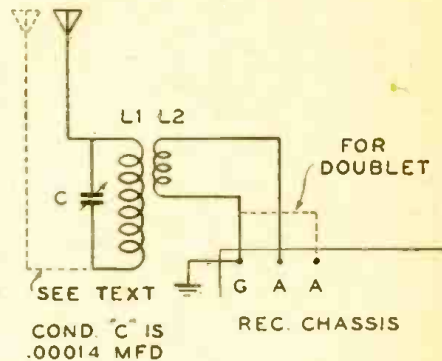

the link coil should be wound in the center of the tuning coil. Use a .00014 mf. tuning condenser because it gives a greater inductance to the capacity ratio.

A tapped coil and a four gang switch could be used, but the individual coils give the best results.

I am using this arrangement on a Stewart-Warner All-Wave Duo Superhet., Model R-120, with fine results. I have heard all continents and scores of amateurs located throughout the world. The length of the antenna and the lead-in is not critical. If the tuner should fail to resonate on any particular band, remove a few feet of wire from the antenna.

JOHN L. BOLLINGER,  
Newburgh, N. Y.

### WATTAGE RECEPTACLE

MOST watt-meters require current transformers, expensive shunts and the like. I submit herewith one which is easily made from odd parts.

A 0-10 volt Jewell movable-vane type voltmeter was used. The meter coil was too high to use "as-is" so we removed turns, to convert it to an A.C. ammeter. Light bulbs were used as a load, and the turns were removed from the bobbin, until a 50-watt



bulb read half-scale. We now have a watt-meter reading between 0-100 watts.

When we get a receiver to repair we immediately put it on the watt-meter receptacle to see how much wattage it consumes. If the wattage is about the same as the manufacturer's rating, we know we can't harm the receiver by letting it run. If the watt-meter shows excessive wattage

we immediately shut it off and the ohmmeter goes to work to find the "short."

The receiver may read slightly lower than normal and still be all right since the power factor of the average transformer is about 80%. Light bulbs were used for calibration since they are non-inductive and cause no phase displacement of current and voltage. For those who don't like to read meter scales, you can calculate the wattage by multiplying the current by voltage by 80% power factor.

GEORGE R. TARR, W8OVN,  
Toronto, Ohio.

**WIRELESS PHONO PLAYER**

The converter tube on my four-tube A.C. superhet is used as a wireless phono player. The grid cap is removed and one lead from the pick-up is connected to it. The other lead is connected to the grid through a condenser about .1 mf. The set is turned on

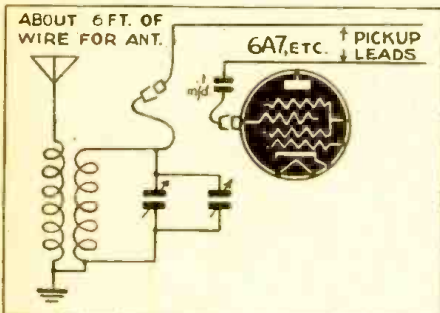

and dialed to 1060 kc. A signal should be heard at about 1500 kc. on the main radio which is located in another room. Reverse the A.C. plug for loudest signal.

A longer antenna may be needed if lights and other electrical appliances are in use. To test this circuit, use a small receiver with one I.F. transformer, as it does not work satisfactorily with receivers using two I.F. and better shielding.

W. L. Doud,  
Mt. Pleasant, Mich.

**POWER PACK FOR PORTABLE RADIOS**

Here is shown a diagram of a power pack that can be used for servicing or electrifying portable radios.

I found this pack to be very useful around

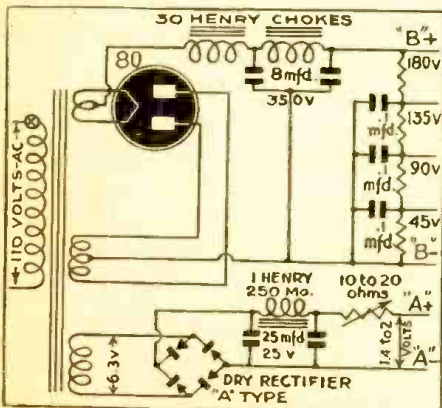

the shop and almost all the parts can be found in the serviceman's or experimenter's junk box.

The power transformer must have a 6.3 volt winding for the "A" voltage.

J. GRAVLICH,  
Brooklyn, N. Y.

**WARTIME SERVICE HINT**

The above sketch shows a resistance-coupled push-pull input circuit to be used where a coupling transformer is not readily available.

R<sub>1</sub> is 40,000 to 70,000 ohms depending upon the impedance of the input tube. R<sub>2</sub> and R<sub>3</sub> are 400,000 ohms. R<sub>4</sub> and R<sub>5</sub> are

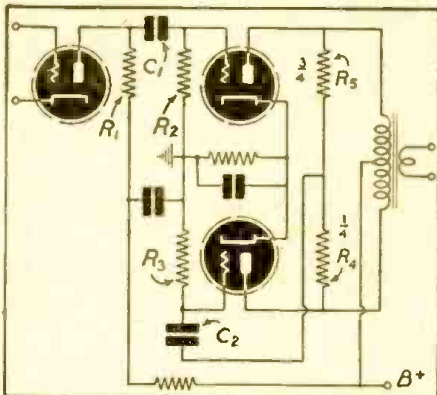

respectively 1/4 and 3/4 megohms for triodes or 1/2 megohm each for pentode output tubes.

Coupling condensers C and C<sub>2</sub> may be .006 to .02 mf.

While not technically a balanced circuit, this hookup gives remarkably good tone fidelity, particularly at the high-frequency end.

PAUL B. FALK,  
Newcastle, Penna.

**A SIMPLE AND INEXPENSIVE BATTERY CHARGER**

By using the circuit illustrated, it is possible to assemble a battery charger at practically no cost. The rectifier may be a burned-out tungar-type tube which has been discarded. The only other apparatus which is necessary to purchase is a Ford spark coil (any ignition coil). In place of a stepdown transformer to reduce the voltage of alternating current to the value required for charging a storage battery, an electric iron is connected in series with the 110 volt circuit (irons consuming between 200 and 600

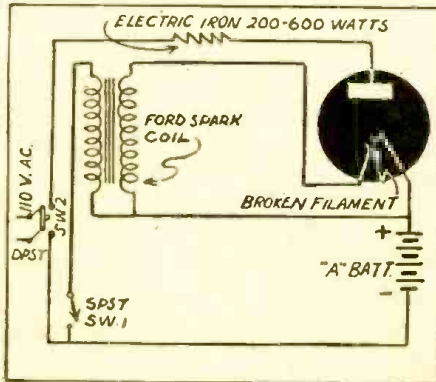

watts). In wiring the charger, the primary winding of the spark coil is connected across the storage battery with a small switch in series. To place the charger in operation connect the 110-volt A.C. circuit by closing the switch No. 2. Next close the switch No. 1 until the high voltage from the spark coil causes an arc to bridge the break in the filament. Now the switch No. 1 may be opened, disconnect battery when charging.

ERNEST GAUDET,  
Lewisville, N.B.,  
Canada.

**TODAY is the time to turn your RADIO JOB into a SECURE POSITION!**

Do You Want a BETTER JOB?—A Secure Future? NOW is the time to prepare Yourself for a Lasting, Profitable Career in Radio Engineering

Don't fool yourself! The good jobs—the permanent positions in radio don't come easy. The sure way to success is to build your future on a sound foundation of knowledge and ability . . . and the ability that you develop now is your assurance of a steady, sure income that will outlast temporary conditions such as the present. Dividends for increased ability have never before been so certain. CREI technical training is designed to do just one thing—to increase your ability, enabling you to hold the more responsible positions which lead to higher salaries. Hundreds of CREI students have accomplished this through the help of CREI training—just as many more hundreds will do in the future!

WRITE FOR FREE BOOKLET TODAY!

Our free booklet and personal recommendations may hold the answer to your success. In your inquiry, please state briefly your background of experience, education and present position.



**CAPITOL RADIO Engineering Institute**

Dept. RC-12, 3224 16th Street, N. W., Washington, D.C.

**RADIO TECHNOLOGY**

RCA Institute offers an intensive two-year course of high standard embracing all phases of Radio and Television. Practical training with modern equipment. Also shorter specialized courses in Commercial Radio Operating, Radio and Television Servicing, and Aviation Communications. For Free Catalog write Dept. RC-42.

**RCA INSTITUTES, Inc.**  
A Radio Corporation of America Service  
75 VARICK STREET NEW YORK

**COMMERCIAL RADIO INSTITUTE**

A radio training center for over twenty years. Well equipped. Excellent faculty. Practical resident courses in Defense, Radio Telegraphy, Broadcast, Servicing, Industrial, Television, Aeronautical, Drafting, Mathematics and Studio Technique. Placement bureau. Classes now forming. Catalog upon request.  
Dept. D, 38 West Biddle Street, Baltimore, Md.

**LEE** Correspondence Courses in **RADIO and ELECTRICAL ENGINEERING**  
**ELECTRICAL ENGINEERING** Get good grasp of wide electrical field. Prepare yourself, at Low Cost, for secure future. Modern, simplified, you can understand quickly.  
**RADIO ENGINEERING** Extra fine course in radio, public address, photo-electric work.  
Trains you to be super-service man, real vacuum tube technician. Exper. kits furnished. Diploma on completion. Tuition, \$25. either course. Deferred payment plan. Get copies of school catalogs, student magazines, complete details. SEND NOW!  
**FREE**  
LINCOLN ENGINEERING SCHOOL Box 931-C47, LINCOLN, NEBR.

Quality of all  
**SOLAR**  
CAPACITORS  
SOLAR MFG. CO. BAYONNE, N. J.

**THE NEW SYLVANIA BASE CHART IS READY —AND IT'S BETTER THAN EVER!**  
**WRITE FOR YOUR FREE COPY NOW!**  
**SYLVANIA ELECTRIC PRODUCTS, INC.**  
Dept. C-12, Emporium, Pa.  
Formerly Hygrade Sylvania Corporation

# Lowest Priced Publications for Experimenters

**10 FOR 50c**

Here is a large number of radio, short-wave, and mechanical "how-to-make-it" designs. Each is a special publication originated by masters in their respective fields. For the low price of 50 CENTS, you buy TEN complete pamphlets with photographic reproductions, complete mechanical layout, and full description to make it possible for anyone to build the project in question.

PLEASE ORDER EACH PROJECT BY ITS PUBLICATION NUMBER, and use the special coupon below. We accept money-orders, cash, checks or new U. S. stamps. (No foreign stamps.) If you send cash or stamps, register your letter. Money refunded if you are not satisfied. ANY TWENTY-FOUR PUBLICATIONS FOR ONE DOLLAR.

## SHORT-WAVE RECEIVER PUBLICATIONS

- HOW TO MAKE THE "OSCILLODYNE" 1-TUBE WONDER SET. No. 101
- HOW TO MAKE THE "19" TWIN-PLEX (ONE TUBE PERFORMS AS TWO) RECEIVER. No. 102
- HOW TO MAKE THE WIZARD, 1-TUBE 50-WATT TRANSMITTER. No. 103
- HOW TO MAKE THE IMPROVED 3-TUBE DOERLE SET FOR BATTERY OPERATION. No. 104
- HOW TO MAKE THE "GO-GET-EM 2" RECEIVER FOR THE BEGINNER. No. 105

- HOW TO MAKE THE 1-TUBE-ALL-ELECTRIC OSCILLODYNE. No. 106
- HOW TO MAKE THE 2 TO 5 METER TWO-TUBE LOUDSPEAKER SET. No. 107
- HOW TO MAKE THE 3-TUBE BATTERY SHORT-WAVE RECEIVER. No. 108
- THE BRIEF-CASE SHORT-WAVE RECEIVER AND HOW TO BUILD IT. No. 109
- HOW TO BUILD THE POCKET SHORT-WAVE RECEIVER. No. 110
- HOW TO BUILD THE CIGAR-BOX 1-TUBE "CATCH ALL" RECEIVER. No. 111

- HOW TO BUILD THE "DUAL-WAVE" SHORT-WAVE BATTERY RECEIVER. No. 112
- HOW TO BUILD THE 1-TUBE "53" TWIN-PLEX" RECEIVER. No. 113
- HOW TO BUILD THE PORTABLE MINIDYNE SHORT-WAVE BATTERY SET. No. 114
- HOW TO BUILD THE HAM-BAND "PEE-WEE" 2-TUBER. No. 115
- HOW TO BUILD THE DUO-AMPLIDYNE. No. 116
- HOW TO BUILD THE "MONO-COIL 2". No. 117

## RADIO BROADCAST RECEIVER AND SPECIAL RADIO PUBLICATIONS

- HOW TO MAKE THE A.C.-D.C. "CASH BOX" RECEIVER No. 118
- HOW TO MAKE BEGINNER'S 2-TUBE ALL-WAVE SET. No. 119
- HOW TO BUILD THE "RADIO-LAMP" 4-TUBE TABLE RECEIVER. No. 120
- HOW TO BUILD A SUPER-SENSITIVE ALL-WAVE CRYSTAL SET. No. 121

- HOW TO BUILD THE 2-TUBE "PENTODE PORTABLE" BROADCAST SET. No. 122
- HOW TO BUILD THE RADIO "TREASURE" FINDER. No. 123
- HOW TO BUILD THE GERNSBACK ONE-TUBE PENTODE LOUDSPEAKER SET. No. 124
- HOW TO BUILD THE WORLD'S SMALLEST ONE TUBE BATTERY RADIO. No. 125

- HOW TO BUILD A 6-TUBE BATTERY ALL-WAVE "FARM PORTABLE" SET. No. 126
- HOW TO MAKE AN A.C.-D.C. ONE-TUBE "DEAF AID". No. 127
- HOW TO BUILD A PIANOTRON. No. 128
- HOW TO BUILD THE ONE-DOLLAR RADIO. No. 129
- HOW TO MAKE A VARIABLE-TONE CODE PRACTICE SET. No. 130

## MECHANICAL PROJECTS PUBLICATIONS

- HOW TO MAKE A SOUTH SEA OUTRIGGER CANOE. No. 131
- HOW TO BUILD A PEE-WEE AUTOMOBILE. No. 132
- HOW TO BUILD A DUAL-CONTROL GLIDER. No. 133
- HOW TO BUILD A HOUSEBOAT ON PONTONS. No. 134
- HOW TO MAKE A BAND SAW FROM OLD AUTO PARTS. No. 135
- HOW TO BUILD A REAL LATHE FOR \$5.00. No. 136
- HOW TO BUILD A SAIL CAT-BOAT. No. 137

- HOW TO BUILD A SIMPLE PORTABLE REFRIGERATOR. No. 138
- HOW TO BUILD A XYLOPHONE. No. 139
- HOW TO BUILD THE ROWMOBILE. No. 140
- HOW TO BUILD LARGE TESLA AND OUDIN COILS GIVING 18-INCH SPARKS. No. 141
- HOW TO MAKE AN ARC WELDER. No. 142
- HOW TO USE AN A.C. ARC WELDER. No. 143

- HOW TO MAKE YOUR OWN MICROSCOPE. No. 144
- HOW TO MAKE A WIMSHURST ELECTROSTATIC MACHINE. No. 145
- HOW TO MAKE A POWER DRILL PRESS FROM SCRAP PARTS. No. 146
- HOW TO BUILD A GOOD LATHE FOR \$1.00. No. 147
- HOW TO MAKE AND EXPERIMENT WITH AN ELECTROPHOROUS. No. 148
- HOW TO MAKE AN ELECTRIC ARC WELDER FROM AN AUTOMOBILE GENERATOR. No. 149

## RADIO PUBLICATIONS, 25 West Broadway, NEW YORK, N. Y. RC 1242

I enclose \$..... for the publications listed by number, at right, at the rate of 50c FOR ANY TEN PUBLICATIONS. NO ORDER FOR LESS THAN 50c ACCEPTED. \$1.00 for 24 publications. These publications are to be sent to me postpaid. I have placed a circle around each number which I want.

	101	102	103	104	105	106
	107	108	109	110	111	112
	113	114	115	116	117	118
	119	120	121	122	123	124
	125	126	127	128	129	130
	131	132	133	134	135	136
Name .....	137	138	139	140	141	142
City .....	143	144	145	146	147	148
						149

## 10 BEST RADIO BOOKS 10 CENTS EACH

- RADIO FANS EVERYWHERE—these fine ten cent text books give you an excellent foundation for the study of RADIO. They are clearly written, profusely illustrated and contain over 15,000 words in each book. You'll be
- No. 1—HOW TO BUILD FOUR DOERLE SHDRT 1-AVE SETS
  - No. 2—HOW TO MAKE THE MOST POPULAR ALL-WAVE 1- AND 2-TUBE RECEIVERS
  - No. 3—ALTERNATING CURRENT FOR BEGINNERS
  - No. 4—ALL ABOUT AERIALS

amazed at the wealth of information contained in these handy books. Excellent for reference—ideal for every technical library. YOUR MONEY BACK if you are not satisfied. PROMPT SHIPMENTS

- No. 5—BEGINNERS' RADIO DICTIONARY
- No. 6—HOW TO HAVE FUN WITH RADIO
- No. 7—HOW TO READ RADIO DIAGRAMS
- No. 8—RADIO FOR BEGINNERS
- No. 9—SIMPLE ELECTRICAL EXPERIMENTS
- No. 10—TELEVISION

### BOOKS ARE ALL UNIFORM

Every book in the GERNSBACK EDUCATIONAL LIBRARY has 32 pages—with illustrations varying from 30 to 66 in number. Each title volume contains over 15,000 words. Positively radio's greatest book buys! If you do not think these books worth the price asked, return them in 24 hours and your money will be instantly refunded.

## RADIO PUBLICATIONS • 25 WEST BROADWAY • NEW YORK, N. Y.

RADIO PUBLICATIONS, Dept. RC-12-42  
25 WEST BROADWAY, NEW YORK, N. Y.

Gentlemen: Please send immediately, POSTPAID, the book numbers circled below. I am enclosing ..... cents—each book being 10c.

Send FREE listing of 48 new 10c publications. PLEASE PRINT CLEARLY

Name ..... Address .....

City ..... State .....

Remit by check or money order—register letter if you send cash or unused U. S. postage stamps.

**MAIL COUPON TODAY!**

## WINDOW DISPLAY IDEA

Following is an idea I am using for window display. I needed some extra light

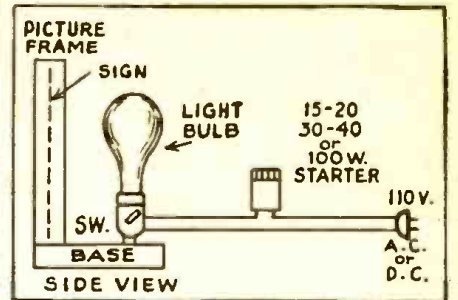

flashes and did not have any on hand. However, I had some extra fluorescent light starters on hand. I tried one and it worked very well.

RALPH KING,  
North Troy, N. Y.

## TWO TEST PRODS FOR A NICKEL!!!

I submit the following as a hint for the making of two test prods for a nickel. Get two pencil clips from the "five-and-ten" for a nickel. Clip off the rounded ball point with the cutting edge of pliers and file to a fine point. Clip to wooden dowels or sticks the

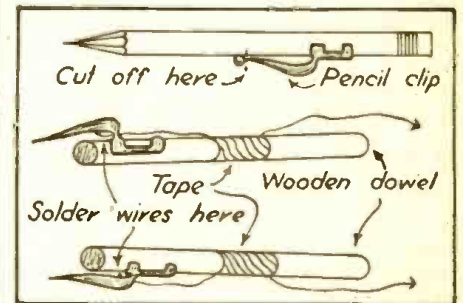

size of a pencil after soldering the lead wires on as shown. Tape the leads to the sticks to keep them from tearing loose from the soldered joints. The other ends of the wires can be attached to any desired source.

GEORGE P. BLACKBURN,  
Tyler, Texas

## ELECTROLYTIC CONDENSER TESTER

This tester will measure the capacity of a condenser and at the same time measure its leakage. To measure the capacity we must use alternating current and as we cannot

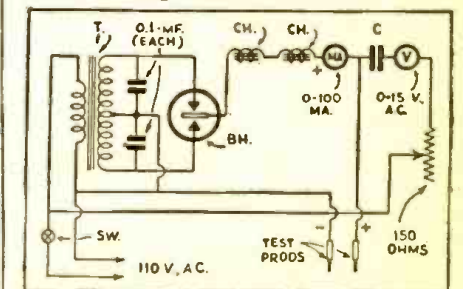

use A. C. alone on an electrolytic condenser a rectifier is employed (a "B" eliminator will do as a substitute) as shown. The voltmeter measures the capacity by calibrating the scale against known condensers and the leakage should not be more than 1, ma. per mfd.

E. A. REDMON

**WAR RADIO JOBS FOR WOMEN**

THERE are eight branches of the military services in which women are needed for radio work. Such was the pronouncement of George W. Bailey, who is chairman of the radio section of the Office of Scientific Research and Development, in Washington.

However, the women must know the Continental code and enough theory to pass the regular amateur radio operator's examination. This is required because the women must have an amateur's radio license in order to qualify for the various positions offered. The work does not include operating with code, as it is principally concerned with the teletypewriter. The jobs open are:

Junior aircraft communication clerks in the Civil Aeronautics Administration. The C. A. A. offers a six months training course, with pay amounting to \$140.00 a year. At the end of the training period the salary is raised to \$1620. Applications should be made to the civil service office in your community.

Instructors are required by the Army Air Forces. \$1620 is paid to those who must take the training course, but experienced radio women can attain \$2,000 at the four schools located at Scott Field, Chicago, Sioux Falls and Madison. The civil service handles these applications also.

Women 16 to 50, who have some knowledge of laboratory technique, may apply to Lieut. John T. Freeman, the Signal Corps General Development Laboratory at Fort Monmouth, Red Bank, N. J. A six months' training course is given during which time the students receive \$120 a month, with a job at the end of the course paying \$135 a month.

In the navy, trained women are needed by the Radio Section, Bureau of Ships. Applications should be made to Lieut. L. B. Wheeler, Room 2N-21, Navy Department, Washington, D. C.

The Naval Ordnance Laboratory, Washington, D. C., wants trained women. Ralph Cautley is the man in charge, and to whom applications should be addressed.

The Naval Research Laboratory at Anacostia, Washington, D. C., likewise needs trained women. Address applications to Fred A. Pierce.

There are a few openings for qualified women at the Radiation Laboratory, at the Massachusetts Institute of Technology, Cambridge, Mass., information about which may be obtained from Dr. F. W. Loomis.

And don't forget that the W.A.V.E.S. offer radio assignments to enlisted women. On the other hand, the W.A.A.C.S., at the present time, do not enlist women for such assignments directly, but it is planned to do so in the future.

**TWENTY WAYS TO USE THE "ELECTRIC EYE"**

(Continued from page 162)

of voltage and resistors, etc., required for

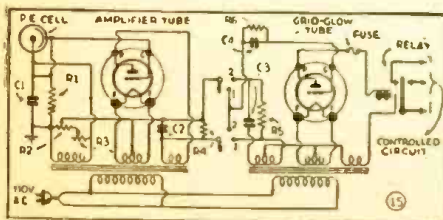

Diagram of a commercial unit for quick-acting application. The P.E. coil actuates an amplifier of the triode type, which in turn "triggers" a grid-glow relay tube into action.

**SPECIAL**

**ABC OF TELEVISION**

Contains latest material on Television developments. It covers theory of scanning; simple television receiver; how the eye sees; the photo-electric cell; neon lamps; need for broad channel width in transmission signals; cathode ray tube and television receivers; Farnsworth system of television transmission; and other important features.

**SHORT WAVE GUIDE**

Covers hundreds of short-wave questions and answers; illustrates popular short-wave kinks; gives building instructions for receivers; simple short-wave test; instruction on the best type of antenna installation; diagram and construction details for building transmitters.

The books listed below have never been sold by us before. The value of each book is 50c. They are exactly the same as RADIO & TELEVISION'S 50c blue books which have been on the market for years.

For a short time only we are selling these at a special reduced price of only 75c for the 3 books.

All of the books contain numerous, photographic illustrations and diagrams and have stiff flexible cover.

**S. W. RADIO QUIZ BOOK**

This book covers questions and answers on transmitters, ultra short-wave receivers, practical kinks, wrinkles and coil winding data; novel hook-ups for experimenters; how to "hook-up" converters, noise silencers, power supplies, modulators, oscillators, antennas, selectors, 5-meter receivers.

**RADIO & TELEVISION**  
25 W. Broadway,  
New York, N. Y.

Gentlemen:

Enclosed you will find remittance for 75c (cash, new U. S. stamps or money order accepted) for which please send me at once four 3 books:

**ABC OF TELEVISION SHORT WAVE GUIDE**  
**SHORT WAVE RADIO QUIZ BOOK**  
PLEASE PRINT CLEARLY

Name .....

Address .....

City ..... State ..... RC-12-42

**LAST CHANCE**

that you will have to buy

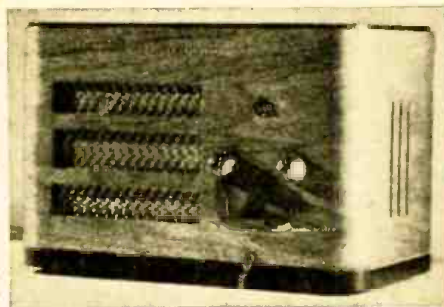

**Crosley CHATTABOX**  
INTERCOMMUNICATION SYSTEM OF TWO UNITS FOR **\$24.75**  
LIST PRICE—\$59.50 A PAIR

Complete two-way wireless loud speaking system. Perfect performance. Plug into any 110 volt house socket A.C. or D.C. Equipped with Call-Listen-Talk switch and volume control.

No installation charges. Modulated carrier signal travels over the electric light lines. **IDEAL FOR OFFICES, STORES, FACTORIES, SCHOOLS, LIBRARIES, HOMES AND WHEREVER INTERCOMMUNICATION IS DESIRED. EXCELLENT SPEECH CHARACTERISTICS.**

Each unit is housed in beautiful 2 tone veneered cabinet with grilled speaker front.

Name .....

Address .....

City .....

**Inventions Wanted**  
Patented or Unpatented

We have been successfully selling inventions, patented and unpatented, since 1924. Write us, if you have a practical, useful idea for sale.

**CHARTERED INSTITUTE OF AMERICAN INVENTORS**

Dept. 109 Barrister Building, Washington, D.C.

**PATENTS — TRADE MARKS**

Booklet concerning Inventions & Patents Form "Evidence of Conception" with instructions for use and "Schedule of Government and Attorneys Fees"—Free

**LANCASTER, ALLWINE & ROMMEL**  
Registered Patent Attorneys

436 Bowen Bldg. Washington, D. C.

the experimental circuits (Figs. 1 to 6 inclusive) are not at all critical but depend upon the sensitivity needed. A little trial and error will soon show the correct values for the particular tube and experiment undertaken.

If this brief article results in stimulating interest in electronic devices, the author will feel genuinely gratified.

**WORLD-TIME CLOCK**

The Only Clock for Universal Use Throughout the Entire World!

A REGULAR CLOCK with A.M. and P.M. divided dial

A WORLD-TIME CLOCK Instantly indicating time in all 24 zones

INTERNATIONAL CLOCK with A.M. and P.M. 24 hour dial

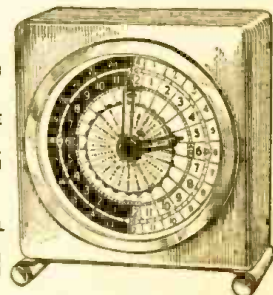

Here is really the first new clock advancement in 200 years—three clocks in one, a world-time clock. It is revolutionary! It is years ahead! The Sky Pilot **WORLD-TIME CLOCK** is the only clock designed for use anywhere in the world. For short-wave fans this clock offers great convenience—it is educational and at the same time indicates world time differences. In a few seconds you can determine the correct time in London, Moscow, Hawaii, Tokyo, Buenos Aires, Halifax—anywhere, American-made—it is exceptionally easy to operate. It carries a guarantee of ninety days against defects in material or workmanship. In modernistic design. It is made of brushed brass—measures 5 1/4" high by 4 3/4" wide—and has convex crystal.

Electric (for A.C. 110-120 volts, 60 cycles) **\$9.95**  
Spring Model **\$8.95**

Remit by check or money order, register letter if you send cash or unregistered U. S. postage stamps.

**GOLD SHIELD PRODUCTS**  
350 Greenwich St. Dept. RC-12 New York City

# ELECTRICAL BRAIN REMEMBERS

**A** MACHINE with a memory, short or long, as desired, is one of the latest achievements of General Electric engineers who work on electronic control devices for military and industrial applications.



With one setting it will remember indefinitely, or it can be set for a short memory.

The memory machine, which was constructed by J. E. Hancock, of the G-E General Engineering Laboratory, makes use of selector relays, similar to those employed in automatic telephone exchanges for picking up the calling line. Each relay consists of a group of little arms, which sweep around in a circle, step by step, making a different contact at each point.

Mr. Hancock compared the operation of the machine to five men in a circle, each corresponding to one of the relays. There is a sixth man, like the interlocutor in an old-fashioned minstrel show, moving around inside the circle, who corresponds to the sixth, or selector, relay.

Although the machine has about 1000 separate connections to various switches and relays in order to operate on four push buttons, it could just as well be made to work on ten, or even more, if any use were found to justify its construction. Instead of flashing lights, it can easily be connected to some other signaling apparatus, such as a series of bells of different pitch.

Enclosed in a metal cabinet the size and shape of a fairly large table model receiver, the front panel displays in addition to various switches, a row of four pushbuttons and four lights. You press the four buttons in any order you choose, and each time one is pushed the corresponding lamp flashes. Then if you press the fifth button off to one side, the lamps flash again in the same order as when the numbered buttons were pushed. The order will be repeated each time the fifth button is pressed; or instead, if a switch is set, the order will be repeated over and over automatically. But if the row of four buttons are pressed in another sequence, the new order is impressed on the device, and repeated thereafter. The machine "remembers" the last four impulses given it.

"As the buttons are pressed," Mr. Hancock explains, "the interlocutor moves from one man to another, giving each a numbered card, corresponding to the button which was pressed, in exchange for an old card. Then he stands in front of the fifth man, and takes up the old card. Now, to obtain repetition, he points with his finger around the circle, and as the men are indicated, they show their cards. This corresponds to the flashing of the lights.

"In forgetting, the interlocutor steps ahead one man, taking up the old card without passing out a new one. When he sweeps around the circle this time, the man in front of whom he was previously standing still now has no card to show."

## PRESENT STATUS OF DIATHERMY

(Continued from page 160)

ical profession, and the manufacturers of diathermy equipment, have all been conducting tests and research experiments in an endeavor to set up a group of standards which can be used for formulating federal regulations.

Electrically these standards have been on the basis of good engineering practice, embracing (a) frequency or frequencies to be used, (b) automatic frequency control, (c) frequency stability, (d) type of emission, (e) maximum power output, (f) harmonic radiation to be effectively suppressed, (g) internal circuits to be effectively shielded, and (h) radiation from power supplies to be eliminated.

Engineers, such as Allan B. DuMont believe that crystal control will be necessary in the new machines, and if possible, inserted into existing equipment.

In summary it might be said that it still remains a problem whether machines can be marketed at reasonable cost if made to meet such rigid requirements. The wartime shortages of materials of course contributes to the difficulty, and time must be allowed for making the improvements.

The F.C.C. is satisfied that any new rules or regulations pertaining to diathermy must provide a time limit of three to four years for compliance.

In the meantime the various committees concerned are still busy on the various aspects of the problem.

## RADIO ENGINEERING IN THE WAR EFFORT

(Continued from page 160)

Europeans with respect to news information. When anything happens they are strongly in the habit of finding out what it is—but quickly! They will not sit in ignorance. They insist upon being informed.

6. The American people are trained, as are no other people, to look to radio for quick news.

7. The American broadcasting system gives good communication into every spot in the country where people are located in any number.

8. Broadcast stations, in numbers sufficient to give adequate news dissemination, can stay on the air without giving aid to the enemy, if certain technical provisions are made, and if proper judgment is used in the information broadcast.

If these factors are correct, and every thoroughly experienced radio engineer knows that they are, why is not the broadcast system already set up and operating as a public war communications system, now that the whole public is in the front line of war? Simply because we lack integration of knowledge and decision.

We engineers have not educated others to know that we have a system available which can be used without any objection.

The public was not in the front lines in the last war, and did not need quick communication. This war is different, but we have not educated old-line thinking to

know that now there is advantage in radio communication to the public comparable with its advantage in communication to tanks and planes. I hope that we can find a way to convince and coordinate the various agencies involved in the use of broadcasting before there is need to use it.

In the design and manufacture of war radio apparatus we will have plenty of difficult problems. We should try to the utmost to design and build with the maximum of standardization and the maximum of reliability. The problem of maintenance of military equipment will be one of huge and increasing difficulty. The enormous quantities of apparatus, the extreme complexities of many types, the scarcity of well-trained servicing personnel, all add up to a tremendous difficulty and even military failure of operations if the apparatus is not well designed and well built.

The story of this war is being written into history. Some of it is behind us, but much more is ahead. The part which radio is playing and will play is being determined by the radio engineers. It is a vital part, and perhaps when the whole story is written it will be seen to have been a determining factor in the outcome. However it may be, we will be in there, doing our best to give all the assistance we can toward the destruction of the most barbarous organizations the world has ever known, in order that we may again proceed with peaceful, orderly development of things for the betterment of mankind.—*Institute of Radio Engineers*

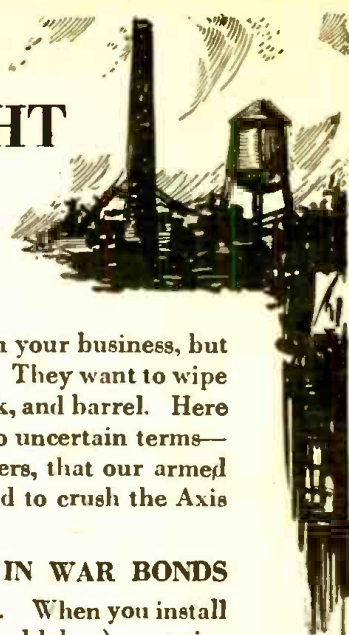

# TARGET FOR TONIGHT

... *Your Business?*

Maybe they won't actually come and drop a *bomb* on your business, but the Axis war lords have their eye on it, just the same. They want to wipe it out as a competitive force—or take it over lock, stock, and barrel. Here is a threat that you can reply to *now*, today, and in no uncertain terms—by buying War Bonds to the very limit of your powers, that our armed forces may have the guns, tanks, and planes they need to crush the Axis *once and for all*.

## THE GOAL: 10% OF EVERYONE'S INCOME IN WAR BONDS

Every American wants the chance to help win this war. When you install the Pay-Roll War Savings Plan (approved by organized labor), you give your employees that chance. For details of the plan, which provides for the systematic purchase of War Bonds by voluntary pay-roll allotments, write: Treasury Department, Section S, 709 12th St. N.W., Washington, D. C.



# Buy War Savings Bonds

This space is a contribution to America's All-Out War Program by

**RADIO-CRAFT**

## DRAW YOUR RADIO BELT TIGHTER

LIKE so many other items, radio parts and radio materials are getting scarcer as the War goes on. As this will be a long war, the radio serviceman, the radio builder, and the radio experimenter will find the going tougher as time goes on. More and more materials will, no doubt, be unavailable for civilian use.

As we have pointed out a number of times editorially, Yankee ingenuity will overcome many of these handicaps, but not all of them. Many substitutions can, and more will be made, in the future. Therefore we will have to use up what we have, use second-hand materials and make other necessary conversions.

Many of our readers have written in lately deploring the fact that they find it

almost impossible to buy wire of any kind.

Now then, wire is a highly strategical material, used in huge quantities by all of our forces and for a thousand different uses in the implements of war. We predict that wire will become more and more unavailable for the duration.

A part solution of the problem, is the wire available in discarded radios and graveyard automobiles. Old burned-out transformers, coils, etc., yield quite a good deal of wire. Bought in this form, the wire is cheap, but of course you will have to unwind it which, however, is not such a difficult job. Such wire can be wound on a reel or spool and can be used over again, the same as if it were new wire. You will be surprised to find out how much wire you can stock

up by such salvaging methods. Burned-out motors, power transformers, etc., can often be bought for a song from the junkman and the wire salvaged.

Radio mail-order houses recently have sent out circulars to their customers explaining the radio parts shortage situation to them.

Allied Radio of Chicago, for instance, in one of their letters, states as follows:

"As you know, the role of Radio in this war is a very important one. Because many of the materials used in making radio parts are very scarce and demands for war uses are very great, the priorities system regulates the flow

*(Continued on page 192)*

## FAMOUS 1-TUBE CIRCUITS

*(Continued from page 174)*

Feedback is too great to allow the electrons on the grid to leak off sufficiently fast to maintain a constant grid potential. The varying grid potential produces a corresponding variation in the plate current, with high amplification. Grid-leak, condenser and tickler coil values are of extreme importance in getting this result.

As will be noted in the schematic diagram, the tickler coil contains as many as, or more turns than the grid coil. The grid condenser is very small (only 50 or 100 mrf.) and a 3 meg. grid leak is used. These values permit variations in the grid potential, instead of the constant potential usually found.

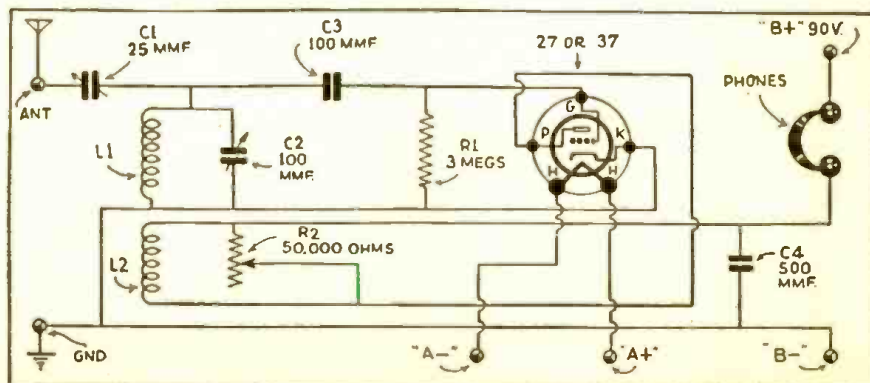

The Oscillodyne—a circuit of the super-regenerative type. Not new, but interesting to the experimenter.

# WHILE THEY LAST

All of the attractive items listed here are brand new. ALL are in PERFECT WORKING ORDER. In many cases, the parts alone total more than the price we are asking. 100% satisfaction guaranteed or your money refunded.  
**ORDER FROM THIS PAGE.** Use the convenient coupon below. Include sufficient extra remittance for parcel post charges, else order shipped express, collect. Any excess will be refunded. C.O.D. shipments require 20% deposit. If full remittance accompanies order, deduct 2% discount. Send money order, certified check, new U. S. stamps. No C.O.D. to foreign countries.

**ORDER TODAY LIMITED QUANTITIES PROMPT SHIPMENTS ASSURED**

### HANDY WORKSHOP OUTFIT

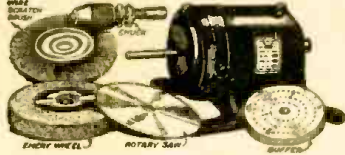

Here is a marvelous article that to the best of our knowledge has never sold at such a low price. This outfit must be seen to be appreciated. It delivers the goods! It comprises a variable speed universal motor for 110 volts A.C. or D.C. Made originally for dictaphone machines by American Gramophone Co. Motor is reconditioned and in excellent condition; all other parts are brand new. Special lever control permits various speeds up to 3000 r.p.m. Measures 7 1/2" x 3 1/2" diam. overall.  
 Included in the outfit are the following items, as illustrated: 1 excellent chuck which takes drills and other tools—chuck is easily screwed to motor shaft; standard emery wheel, 1" diameter; fine steel rotary saw, 4" diameter; wire scratch brush, 4" diameter; standard cloth buffer, 3" diameter. Total Wt. 9 lbs.

ITEM NO. 149  
 Complete outfit, including motor. **YOUR PRICE \$5.95**

### VARIABLE SPEED UNIVERSAL MOTOR FOR 110 VOLTS, A.C. OR D.C.

Made for Dictaphone machines by American Gramophone Co. Used, but in excellent condition. Special lever control permits variable speeds up to 3000 r.p.m. 1 1/2" shaft extends from both sides of motor. Measures 7 1/2" x 3 1/2" diam. overall. Shp. Wt. 6 3/4 lbs.

ITEM NO. 111  
 Your Price **\$2.95**

### WESTON MODEL 562 A.C.-D.C. AMMETER

Designed by Weston for the Eastman Kodak Co. It is a precision-built machine—same type ammeter which, with suitable shunts, can be used as a milliammeter too. It is 2" in diameter and defused for panel mounting. Bakelite base and black-enameled cover. Shp. Wt. 2 lbs.

ITEM NO. 35  
 Your Price **\$1.25**

### POWERFUL ALL-PURPOSE INDUCTION MOTOR IDEAL FOR EXPERIMENTERS—101 USES

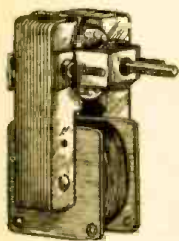

Sturdily constructed to precision standards, this self-starting shaded pole A.C. induction motor is powerful enough for large variety of uses. Some of these are: Automatic Timing Devices, Current Interrupters, Electric Fans, Electric Chimes, Window Displays, Photoall Control Devices, Electric Vibrators, Small Grinders, Buffers and Polishers, Miniature Pumps, Mechanical Models, Sirens, and other applications.

Consumes about 15 watts of power and has a speed of 3,000 r.p.m. When geared down, this sturdy unit will constantly operate an 18-inch turntable loaded with 200 lbs. dead weight—**THAT'S POWER!**  
 Dimensions: 3" high by 2" wide by 1 1/2" deep; has 4 convenient mounting studs; shaft is 3/8" long by 3/16" diameter, and runs in self-aligning oil-retaining bearings. Designed for 110-20 volts, 50-60 cycles. A.C. only.  
 ITEM NO. 147  
 Your Price **\$1.45**

### 100 POWER TELESCOPE LENS KIT

Make your own high powered 6 ft. telescope! Now you can thrill to a close-up view of the worlds out in space. See the rings around Saturn, the mountains of the moon! Kit contains 3" diam., 75" focal length, ground and polished objective lens and 2 astronomical eye-pieces, magnification 50x and 100x. Complete kit with full instructions.  
 ITEM NO. 123  
 Your Price **\$1.95**

### WESTERN ELECTRIC BREAST MIKE

This is a fine light-weight aircraft carbon microphone. It weighs only 1 lb.  
 Mike comes with breast-plate mounting and has 3-way swiveling adjustment so that it can be adjusted to any desired position. There are 2 woven straps, one goes around neck, the other around chest. Straps can be snapped on and off quickly by an ingenious arrangement.  
 This excellent mike can be adapted for home broadcasting or private communication systems. It can be used as desk mike.  
 Comes complete with 6-foot cord and hard rubber plug. Finished in sherdurized plate, non-rustable.

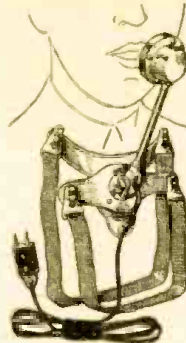

ITEM NO. 152  
 Your Price **\$1.45**

### METAL CUTTING SAW

Here is an ideal metal-cutting saw made of fine tool steel specially designed to cut metal. Teeth are set at a special double angle for metal-cutting work. Saw is specially hardened for long and extended use; measures 3 1/2" diameter; center hole is 1/2" square; thickness 42/1000 (42 mils.) 3/64".

ITEM NO. 151  
 Your Price **50c**

### POWER ADJUSTABLE RHEOSTAT

Here is an excellent rheostat used especially to regulate speeds of small motors, such as our Handy Workshop Outfit. This rheostat can be used in connection with motors up to 1/20 h.p.  
 This fine rheostat is wire-wound on porcelain insulation. The black enamel steel casing is perforated for ventilation. Adjustable handle regulates speed of motor easily and smoothly. Size 5 1/2 x 2 1/4" overall. Shp. Wt. 2 lbs.

ITEM NO. 153  
 Your Price **\$1.45**

### AMAZING BLACK LIGHT!!

Powerful 250-Watt Ultra-Violet Source  
 The best and most practical source of ultra-violet light for general experimental and entertainment use. Makes all fluorescent substances brilliantly luminescent. No transformers of any kind needed. Fits any standard lamp socket. Made with special filter glass permitting only ultra-violet rays to come through. Brings out beautiful opalescent hues in various types of materials. Swell for amateur parties, plays, etc., to obtain unique lightning effects. Bulb only. Shp. Wt. 1 lb.  
 ITEM NO. 87  
 Your Price **\$2.00**

### WATTHOUR METER

Completely overhauled and ready for immediate service. Designed for regular 110-volt, 60 cycle 2-wire A.C. circuit. Servicemen use it in their shops to check current consumption of sets, soldering irons, etc. Keeps cost down. If dismantled the parts alone would bring the price. The intricate gear train could be used as a counter on machines of various kinds. Simple to install; 2 wires from the line and 2 wires to the load. Sturdily constructed in heavy metal case. Size: 2 1/4" high, 2 1/2" wide, 5" deep. Westinghouse or General Electric. Shp. Wt. 14 lbs.  
 ITEM NO. 33  
 Your Price **\$4.95**



## BEGINNER'S 1-TUBE S.W. SET

(Continued from page 176)

this position. It may be necessary, particularly in the smallest coil, to add a turn or two to the tickler (the coil between the P and F socket terminals). Since the tube must be a good one—a poor tube will not oscillate—before going into the business of adding turns it might be well to try another tube.

And while on the subject of tubes, heed the warning that the 2 V. series of tubes are very delicate and must be handled with extreme care. They will not stand an overload on the filaments—if this occurs, either from too much plate current or too much filament voltage, the emission from the filament is destroyed and the tube is rendered useless. In this particular circuit do not put more than 6 1/2 V. of "B" battery in use (less, if possible).

### COIL DATA

It is advised that the beginner purchase a set of coils already wound, but if desired he may wind coils to the data given in Fig. 3. The coils are all wound on standard short-wave plug-in forms 1 1/4 ins. diameter x 2 1/8 ins. long, four prong. The tuned winding is connected between the grid prong and one filament prong and the tickler between the plate and the other filament.

The specifications given in Fig. 3 for the broadcast coil simply mean that the wire is to be wound solid (one turn against the next) for the distances given. This is easier than counting turns when there are as many as in this case.

Be sure to wind all coils the same way (in the same direction) and connect the same ends to the same prong. Otherwise, some coils will oscillate and others will not.

### List of Parts

- One Hammarlund Star tuning condenser, 140 mmf., C1;
- One Hammarlund 5 to 70 mmf. balancing condenser, C2;
- One 350 mmf. mica grid condenser, C3;
- One .002-mf. mica condenser, C4;
- One .1-mf. non-inductive paper condenser, 200 V., C5;
- One 2 meg. grid leak, R1;
- One 50,000 ohm wire-wound potentiometer, R2;
- One 4-prong socket for coils L1-L2;
- One 5-prong spring mounted socket for the tube;
- Four spring binding posts;
- One wood baseboard, 8 1/2 x 9 x 1/2-in.;
- One aluminum panel, 8 1/2 x 6 x 1/16-in.;
- One type 33 tube, V1;
- One pair of sensitive headphones;
- One roll of push-back hook-up wire;
- Three 2 1/2 V. small "B" batteries;
- One 2 V. storage cell;
- Small screws;
- Four Fahnestock clips;
- One vernier dial.

## TOOLS FOR AUTO RADIO CONTROLS

Quite often customers bring auto radio sets into our shop for repair which they remove from their car and leave the control cable in the car. This of course makes it difficult to work on the set without suitable means of turning the tuning and volume controls.

The writer has made several tools for this purpose from the adapter end pieces of control cables which are available through practically any local jobber. The most popular types are ones with a two prong fork shaped key and a single blade key. These can be soldered on the end of inexpensive screwdrivers and they will be found very useful when working on auto sets.—Edgar Carnes, South Zanesville, Ohio

—From C-D Capacitor.

## HUDSON SPECIALTIES CO., 40 West Broadway, N. Y. C.

IT'S EASY TO ORDER—CLIP COUPON—MAIL NOW ORDER FROM THIS PAGE.

HUDSON SPECIALTIES CO., 40 West Broadway, Dept. RC-12-42, New York, N. Y.  
 I have circled below the numbers of the items I'm ordering. My full remittance of \$..... (Include shipping charges) is enclosed.  
 OR my deposit of \$..... is enclosed (20% required), ship order C.O.D. for balance. No C.O.D. order for less than \$2.00. (New U. S. stamps, check or money order accepted.)  
 Circle item No. wanted: 11, 33, 35, 87, 123, 147, 149, 151, 152, 153  
 Name..... Address.....  
 City..... State.....  
 Send remittance by check, stamps or money order; register letter if you send cash or stamps.



# Book Reviews

**THE FUTURE OF TELEVISION** by Orrin E. Dunlap, Jr. Published by Harper & Brothers, Publishers. Stiff cloth covers, size  $5\frac{1}{2} \times 8\frac{1}{2}$  ins., 194 pages. Price \$2.50.

Television has been called a thirty million dollar "it". That's what the statisticians have calculated that research and development in television has cost up to 1942. The purpose of this book is to show why and how that "it" might be removed, when the new radio service (which ought to become a billion-dollar industry), moves forward from the basis provided by the pioneers.

Television, with its eye and ear appeal, is motion pictures with sound. (That the sound comes via radio is secondary to the subconscious mind). Sports, and news events and plays,—that's television. Perhaps the day will come when scientific experiments and similar educational features will be televised to the student in the far-off places.

Television is not a one-man job. Brains, money, hands, scientific management and showmanship are needed. Thousands of engineers, actors, scenic designers, scenario writers, beauticians, cameramen, musicians, stylists and merchandisers; all these will help make this an industry.

But getting down to commercial facts, the author points out the advantages of television to sponsors. Something satisfactory to everyone will probably be worked out.

From the home viewer's standpoint the indications seem to be "leasing" of sets, for many years to come, before outright ownership and responsibility of maintenance can be assumed.

As regards actors and others to appear before the television camera, not all of them will be "telegenic." Possibly new types, new faces, new personalities, will come up before us; although there is no reason why the standard motion pictures cannot be telecast.

Associated with radio since 1912, the author has seen the milestone demonstrations of television. He has discussed its problems with the scientists and the industrial leaders through whose foresight the "big show" has been developed.

For those who want the complete history of television to date, this is the book.

**FUNDAMENTALS OF ELECTRIC WAVES** by Hugh H. Skilling. Published by John Wiley & Sons, Inc. Stiff cloth covers, size  $6 \times 9$  ins., 186 pages. Price \$2.75.

In these days of ultra-high frequency, engineers and technicians speak familiarly of waves, wave guides, radiation, reflection, polarization, and other similar matters, which until recently were considered as rather academic.

Rather suddenly, because of the war, this change came about. The Navy Department, for example, now recommends as a training course for ensigns, studies in reflection and refraction of electric waves, and antenna design and theory. Even the Secretary of War in the daily press says that "intense study must be given wave echoes of radio."

Therefore since electric waves have become so important to so many persons, this book appears timely, embracing as it does material that formerly existed only in lecture notes and mimeographed form.

The purpose of the work, of course, is to introduce the reader to the subject of electric emanations in the form of waves. The principles of wave action, and the basic ideas

of Maxwell's equations, are presented in a manner that has proved to be readily understandable to most students. The ideas are discussed and illustrated in simple exercises until they have become thoroughly familiar.

Physical concepts are stressed, with engineering practice kept well in mind as well as the mathematical frame work. A radio engineer or technician may thus find this book very helpful in comprehending antenna arrays, transmission lines, wave guides, reflectors, resonators, and electromagnetic horns. Possibly he may even come to see wave theory analogies in the behavior of a receiving antenna, or a vertical radiator for a broadcast transmitter. And the advanced student will find this work helpful as an introduction to some of the more complex electromagnetic theories.

The opening chapters are concerned with electrostatics, the use of vector analysis, etc., which may be fascinating to some, tedious to others, and decidedly discouraging to the impatient. But this cannot be helped, for you cannot have waves without electric and magnetic fields, and you cannot understand a field, without the fundamentals.

All in all, an excellent text to add to the library of wartime radio studies.

**SUPER-ELECTRICITY** by Raymond F. Yates. Published by D. Appleton-Century Co., Inc. Stiff cloth covers,  $5\frac{1}{4} \times 7\frac{3}{4}$  ins. 163 pages. Price \$2.00.

Here is the story of electronics, right up to 1942, in language that anyone can understand. It is not full of engineering calculations, nor mathematics, nor any esoteric jargon. It tells simply and directly what is being done with photo-electric cells in industry, medicine, and radio.

One cannot help becoming enthusiastic about the future that lies in this field after the war. It has possibilities that far transcend present-day radio.

The work of the early workers—Edison, Fleming, DeForest, Fessenden and Alexander, J. J. Thompson, Rutherford, Millikan and Crookes—even these have been contributions to 1942 electronics.

The author goes into great detail to show what is done with electronic circuits, how they are used, why they are used, how much money or time is saved, or improvement in quality or count is attained.

First principles are made easy. The attic experimenter or constructor can make his own P. E. cells and conduct experiments to his heart's content. The reader who works in a machine shop or on a production line will be interested in how machines and operations can be controlled.

Suggestions are given for setting up one's self in business—a business where throats don't have to be cut to survive. And don't forget electronic music. Many experimenters have gone into this already, and there will be more and more of it as time goes on.

If you have to look for a job in this field, the author gives some excellent pointers, whether you be a salesman, recording engineer, or technician, for the usual employment agencies can help you little. In the field of sound alone, there are big chances of success.

Then what might be called the serious side to consider is the study of electronics in colleges or at home. Home study of course would feature foundation subjects.

All in all, there are big things ahead in electronics. The world can use more Edi-

sons, Thompsons, Teslas and Brushes in this New Era of Super-Electricity.

**ELECTRICAL FUNDAMENTALS OF COMMUNICATION** by Arthur L. Albert, published by McGraw-Hill Book Co., Inc. Stiff cloth covers,  $6 \times 9$  ins., 554 pages. Price \$3.50.

Designed for the student of communication and the worker in the communications industry, this text presents the electrical fundamentals upon which his industry is based, embracing the three divisions of radio, telephony and telegraphy, with their allied branches.

The book is well balanced. Illustrations and examples are included from all fields concerned, and the theories and explanations given will withstand rigorous examination. The terminology used and the presentations are simple and direct, suitable for beginner students rather than for engineers.

For once a work omits the usual hydraulic and mechanical analogies. The facts are presented in electrical language, which can be learned correctly the first time. The diagrams illustrating the basic actions see to that. And electronics, instead of coming at the end of the book (as in the old texts) constitutes the very first chapter.

The remaining chapters are right up to date and cover Bridge Circuits, Electric Networks, Transmission of Electro-Magnetic Waves, Fundamentals of Vacuum Tubes, and Electro-Acoustics, in addition to the basic Direct Current, Ohm's Law, and Alternating Current chapters. Modern electric measuring instruments are also included, and Vacuum Tubes as circuit elements.

In our opinion, this is an excellent text to supplement the studies of students in the various radio schools, or for a foundation text for the home student.

**FREQUENCY MODULATION**, by August Lund, published by McGraw-Hill Book Company, Inc. Stiff cloth covers, size  $6 \times 9$  ins., 375 pages. Price \$4.00.

This is an engineering text covering basic principles of frequency modulation, and the design of commercial apparatus and antennae for the transmission thereof. Intended primarily for broadcast engineers, and designers of transmitters and receivers, the work will no doubt be regarded as an exhaustive reference by the advanced student and experimenter.

While highly technical, the book contains excellent diagrams and graphs in generous amounts to illustrate the ideas and concepts discussed in the text. This is a feature which the serious reader will appreciate, for he has so often come up against works which lack sufficient illustrative matter.

The author stresses the fact that frequency modulation consists of high-fidelity transmission, and modulation that is free from the interference that occurs with transmission by means of carrier currents, and that the practical applications described follow closely good present-day engineering practice.

He believes that a thorough knowledge of the principles underlying frequency modulation must be the first step in the design of apparatus.

FM is compared to PM and AM so that

(Continued on next page)

**NOW—A REALLY HIGH-POWERED—  
Radio Engineering  
Library**

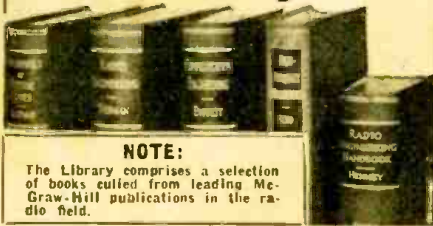

**NOTE:**

The Library comprises a selection of books culled from leading McGraw-Hill publications in the radio field.

- especially selected by radio specialists of McGraw-Hill publications
- to give most complete, dependable coverage of facts needed by all whose fields are grounded on radio fundamentals
- available at a special price and terms

THESE books cover circuit phenomena, tube theory, networks, measurements, and other subjects—give specialized treatments of all fields of practical design and application. They are books of recognized position in the literature—books you will refer to and be referred to often. If you are a practical designer, researcher or engineer in any field based on radio, you want these books for the help they give in hundreds of problems throughout the whole field of radio engineering.

**5 VOLUMES, 3319 PAGES, 2289 ILLUSTRATIONS**

1. Eastman's FUNDAMENTALS OF VACUUM TUBES
2. Terman's RAD I ENGINEERING
3. Everitt's COMMUNICATION ENGINEERING
4. Hund's HIGH FREQUENCY MEASUREMENTS
5. Henney's RADIO ENGINEERING HANDBOOK

10 days' examination. Easy terms. Special price under this offer less than books bought separately. Add these standard works to your library now; pay small monthly installments, while you use the books.

**10 DAYS' FREE EXAMINATION—SEND COUPON**

McGraw-Hill Book Co., 330 W. 42nd Street, N. Y. C.

Send me Radio Engineering Library, 5 vols., for 10 days' examination on approval. In 10 days I will send \$9.00 plus few cents postage, and \$3.00 monthly till \$24.00 is paid, or return books postpaid. (We pay postage on orders accompanied by remittance of first installment.)

Name .....

Address .....

City and State .....

Position .....

Company .....

**DRAFTEES,  
\*\*\*\*\* ATTENTION! \*\*\*\*\***

It's up to you to secure a higher rank and better pay and you can do it in your own home with the Candler System. Over a quarter of a century experience in successfully teaching Radio Code. This easy, simplified method of learning Radio Code has trained thousands. There are courses for beginners and operators wishing maximum code proficiency. There is a big demand for Radio Code operators right now! . . . Send a post card today for the

**FREE! BOOK OF FACTS**

Tells you all about this fascinating work . . . your copy is waiting for you, there is no obligation . . . send for it today!



**CANDLER  
SYSTEM CO.**

BOX 928  
Dept. S-12 Denver, Colorado

**BOOK REVIEWS—Continued**

(Continued from page 191)

a clear understanding of the three types of modulation is obtained. Simultaneous occurrence of frequency modulation with either one of the other two types, or simultaneous action of all three, is treated in the theoretical part of the book. This was done in order to show that an amplitude limiter can be used successfully, and without producing distortion, only when amplitude—variations are not set up in the primary frequency modulation stage, by the same source that originates the desired frequency modulation. Besides, the theory of superposition may suggest other applications not yet in use.

**DRAW YOUR RADIO BELT  
TIGHTER**

(Continued from page 189)

of radio components on the following basis:

1. For production of radio equipment required to carry on the war.
2. For repair and maintenance of war equipment.
3. Any surplus after war uses, for repair and maintenance of existing radio receivers.

Radio training classes, government sponsored to promote the war effort, may obtain radio parts and kits, of course, by extending necessary priority ratings.

All of our manpower, resources, and facilities are mobilized to speed the supply of vital radio materials for the war effort. We know that's the way you would want it.

But many Radio Parts for Replacements Are Still Available Without a Priority. We can ship a large variety of radio parts for replacement purposes immediately from our stocks without priorities."

**YOU CAN BUY RADIO PARTS**

(Continued from page 165)

be required to furnish a priority to the supply house. But the supply house, which deals with the manufacturers, must use Form PD-1X in order to obtain parts, etc.

In other words it has been made easier for the parts-buyer to get what he wants, as the jobber is able to maintain a satisfactory link between manufacturer and consumer.

As announced in our November issue, vacuum tubes will be available, and will be included under this new arrangement.

**JUNK RADIOS AND PARTS  
DISAPPEARING**

A survey of Cortlandt Street (New York's Radio District) last month showed that the war is having its effect. The stores which used to have old radios, amplifiers, cabinets, phonographs, auto radios and eviscerated chassis, sitting out on the sidewalk in front of them, are no more.

The schools that are teaching the young men fundamentals of radio for the army have gobbled up almost all of this material. They could not easily get new parts and sets, so they did the next best thing and grabbed up the derelicts of Cortlandt and Washington Streets.

They tear these down to the ultimate components and then the students build up bread-board layouts from 1-tuber's to superhets. This gives excellent practice and makes good use of the old material. Nothing is wasted. Heavy metal chassis are given to the salvagers, for the war effort.

Some far-seeing servicemen also have bought up "junkies"—old T. R. F. midgets and table models, and are using the parts.

**Radio Servicemen and Dealers!!**

Write for our new circular of radio parts and accessories. All items in stock, immediate delivery, no waiting.

**SIGMON RADIO SUPPLY**

708 Blisley Ave., Charleston, W. Va.

**Index to advertisers**

Amperite Co. ....	155
Audel & Co., Theo. ....	Back Cover
Audiograph .....	133
Burstein-Applebee Co. ....	163
Candler System Co. ....	192
Cannon Co., C. H. ....	177
Capitol Radio Engineering, Inc. ....	185
Chartered Institute of America .....	187
Commercial Radio Institute .....	185
General Cement Mfg. Co. ....	183
Gold Shield Products .....	187
Hallcrafters, Inc. ....	Inside Back Cover
Harrison Radio .....	184
Henry Radio .....	159
Hudson Specialties Company .....	190
International Projectionist .....	181
International Resistance Co. ....	131
Korrol Mfg. Co. ....	187
Lancaster, Allwine & Rommel .....	187
Lincoln Engineering School .....	185
McGraw-Hill Book Co. ....	192
Mass. Radio School .....	133
Melville Aeronautical Radio School .....	133
Meissner Manufacturing Co. ....	160
Mirror Record Corp. ....	183
National Radio Institute .....	129
National Union Corp. ....	158
Nelson Company .....	177
Ohmite Manufacturing Co. ....	132
Opportunity Adlets .....	163
Peerless Radio & Sound Corp. ....	178
Popular Homecraft .....	163
Radcraft Publications, Inc. 168, 175, 181	181
RCA Institutes .....	185
Radio Publications .....	186
Radio-Television Institute .....	177
Radio & Television .....	181, 187
Kadolek Company .....	157
Readrite Meter Works .....	155
Sigmon Radio Supply .....	192
Solar Manufacturing Co. ....	185
Sprague Products Co. ....	167
Sprayberry Academy of Radio .....	179
Supreme Instruments Corp. ....	183
Sylvania Electric Products, Inc. ....	185
Technifax .....	179, 180
Teleplex .....	163
Triplet Electric Instruments Company .....	Inside Front Cover
United States Army Recruiting & Induction Service .....	134
University Laboratories .....	177
X. L. Laboratories .....	177

(While every precaution is taken to insure accuracy, we cannot guarantee against the possibility of an occasional change or omission in the preparation of this index.)



## **Battle Flags!**

All of us at the Hallicrafters are both proud and humble to have important assignments in defeating America's enemies.

That our efforts have justified the award of the famous Army-Navy "E" flag is a great honor. We shall keep it proudly flying.

**all of the hallicrafters**

# PRACTICAL RADIO INFORMATION

Including Frequency Modulation—Television, etc.

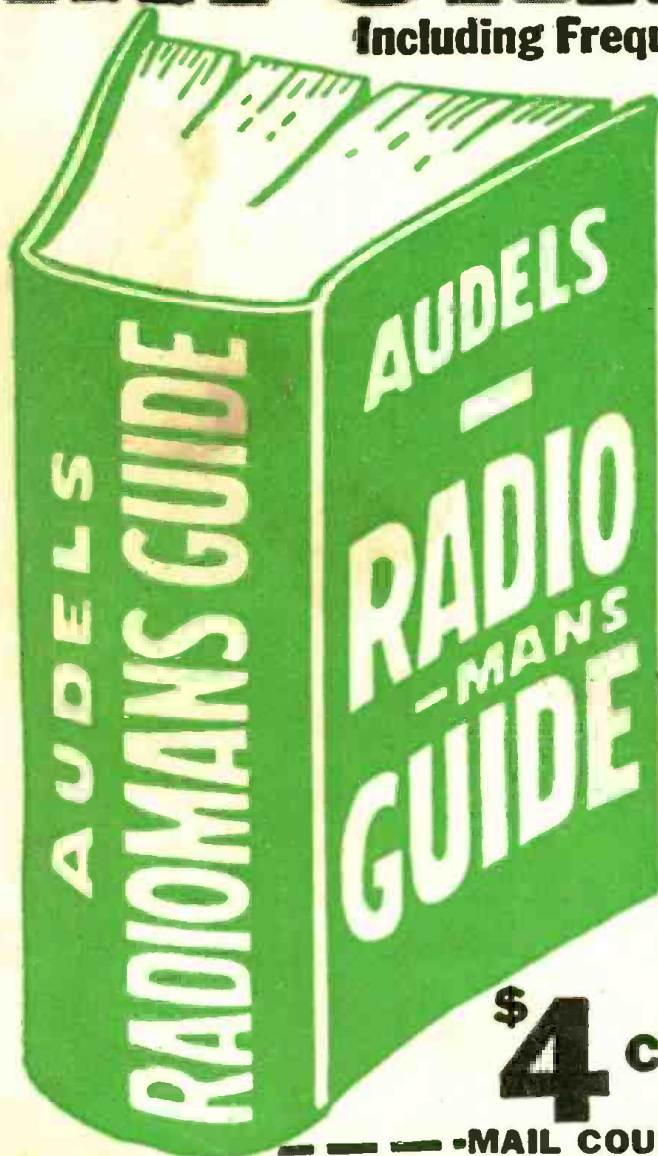

Inside Information for all Servicemen—Aircraft Pilots, Students.

**772 PAGES, 400 DIAGRAMS**

is complete—gives Authentic Principles & Practices in Construction, Operation, Service & Repairs. Covers clearly and concisely Radio fundamentals—Ohm's Law—Physics of sound as related to radio science—Measuring instruments—Power supply—Resistors—Inductors—Condensers—Transformers and examples—Broadcasting stations—Radio Telephony—Receivers—Diagrams—Construction—Control systems—Loud speakers—Antennas—Auto Radio—Phonograph pickups—Public Address Systems—Aircraft & Marine Radio—Radio Compass—Beacons—Automatic Radio Alarms—Short Wave—Coil Calculations—Testing—Cathode ray oscillographs—Static Elimination—Trouble Pointers—Underwriter's standards—Units & tables. REVIEW QUESTIONS—Ready Reference Index.

**\$4**

**COMPLETE • PAY \$1 A MO.**

To get this practical information in handy form—Fill in and

—MAIL COUPON TODAY.—

**AUDEL, Publishers; 49 West 23rd St., New York**  
 Mail AUDELS NEW RADIOMAN'S GUIDE for free examination. If O. K. I will send you \$1 in 7 days; then remit \$1 monthly until \$4 is paid. Otherwise I will return it.

Name \_\_\_\_\_ R.C.F.

Address \_\_\_\_\_

Occupation \_\_\_\_\_

Reference \_\_\_\_\_

Please Note:

If you do not wish to mar this page by clipping coupon—send letter or penny postcard instead.

# ADV Plans, LLC

## Copyright Notice:

The entire contents of this CD/DVD are copyright 2014 by ADV Plans, LLC. All Rights Reserved.

Reproduction or distribution of this disk, either free or for a fee is strictly prohibited. We actively monitor and remove listings on eBay thru Vero.

You are free to copy or use individual images in your own projects, magazines, brochures or other school projects.

Only the sellers listed here are authorized distributors of this collection:  
[www.theclassicarchives.com/authorizedsuppliers](http://www.theclassicarchives.com/authorizedsuppliers)

Please view our other products at  
[www.theclassicarchives.com](http://www.theclassicarchives.com),  
or our ebay stores:

[TheClassicArchives](#)  
[ADVPlans](#)  
[SuperShedPlans](#)

